

Table of Contents

1 Description	12
1.1 General Description	12
1.2 Control panel	12
1.3 Cooktop	13
1.4 Other parts	14
1.5 Available accessories	15
2 Use	16
2.1 Using the accessories	18
2.2 Using the cooktop	18
2.3 Settings menu	32
2.4 User menu	34
2.5 Error codes	37
2.6 Using the oven	38
2.7 Programming clock	39
2.8 Using the temperature probe	43
2.9 Cooking advice	46
3 Cleaning and maintenance	50
3.1 Cleaning the cooktop	51
3.2 Cleaning the door	52
3.3 Cleaning the oven cavity	53
3.4 Steam clean function	54
3.5 Extraordinary maintenance	55

Definitions

This manual contains important safety symbols and instructions. Please pay attention to these symbols and follow all instructions given.



WARNING

This symbol will help alert you to situations that may cause serious bodily harm, death or property damage.



CAUTION

This symbol will help alert you to situations that may cause injury or property damage.

We advise you to read this manual carefully, which contains all the instructions for maintaining the appliance's aesthetic and functional qualities.

For further information on the product: www.smeg.com



Important Safety Instructions

IMPORTANT SAFETY INSTRUCTIONS

Important Note to the Customer



WARNING: Tip Over Hazard

- A child or adult could tip the range over and be killed.
- Verify the anti-tip device has been properly installed and engaged.
- Ensure the anti-tip device is re-engaged when the range is moved.
- Do not operate the range without the anti-tip device in place and engaged.
- Failure to follow these instructions can result in death or serious burns to children and adults.



Warnings and important instructions appearing in this guide are not meant to cover all possible conditions and situations that may occur. Common sense, caution, and care must be exercised with installing, maintaining, or operating your appliance.

- Check for proper installation and use of the anti-tip bracket. Carefully tip the range forward by pulling it from the back to ensure that the anti-tip bracket engages the range leg and prevents tip-over. The range should not move more than 1" (2.5cm).
- Read all instructions before using this appliance.
- Keep these instructions with your owner's guide for future reference.

Do not attempt to install or operate your appliance until you have read the safety precautions in this manual. Safety items throughout this manual are labeled with a WARNING or CAUTION statement based on the risk type.

Unpacking and installation

- Remove all tape and packaging before using the appliance. Dispose of the carton and plastic bags after unpacking the appliance. Never allow children to play with packaging material. Do not remove the wiring label and other information attached to the appliance. Do not remove model/serial number plate.

Important Safety Instructions



- Cold temperatures can damage the electronic control. If this appliance has not been used for a long time, make sure that it has been stored at temperatures above 32°F (0°C) for at least 3 hours before turning on power to the appliance.
- Never modify or alter the construction of the appliance by removing the leveling legs, panels, wire covers, anti-tip brackets/screws, or any other part of the appliance. Be sure to have an appropriate foam-type fire extinguisher available, clearly visible and easily accessible located near the appliance.
- All materials used in construction of cabinets, enclosures, and supports surrounding the product must have a temperature rating above 200°F (94°C).
- Proper Installation—Be sure your appliance is properly installed and grounded by a qualified technician. In the United States, install in accordance with the National Fuel Gas Code ANSI Z223.1/NPFA No. 54, latest edition and National Electrical Code NFPA No. 70 latest edition, and local electrical code requirements. In Canada, install in accordance with CAN/CGA B149.1 and CAN/CGA B149.2 and CSA Standard C22.1, Canadian Electrical code, Part 1-latest editions and local electrical code requirements. Install only as per the installation instructions provided in the documentation received with this appliance.
- For personal safety, this appliance must be properly grounded. For maximum safety, the power cord must be securely connected to an electrical outlet or junction box that is the correct voltage, is correctly polarized and properly grounded, and protected by a circuit breaker in accordance with local codes.

Grounding instructions



WARNING

- Avoid fire hazard or electrical shock. Failure to follow this warning may cause fire, serious injury, or death.
- Avoid fire hazard or electrical shock. Do not use an adapter plug, an extension cord, or remove the grounding prong from the power plug. Failure to follow this warning may cause fire, serious injury, or death.



Important Safety Instructions

- It is the personal responsibility of the consumer to have the appropriate outlet or junction box with the correct, properly grounded wall receptacle installed by a qualified electrician. It is the responsibility and obligation of the consumer to contact a qualified installer to ensure that the electrical installation is suitable and in conformance with all local codes and ordinances.
- See the installation instructions provided with this appliance for complete installation and grounding instructions.
- Do not touch surface cooking zones, areas near these zones or elements, interior surfaces of the oven, or the warmer drawer (if provided). Surface and oven elements may be hot even though they appear to be cool. Areas near surface elements may become hot enough to cause burns. During and after use, do not touch, or let clothing or other flammable materials come into contact with these areas until they are cool. These areas may include the cooktop, surfaces facing the cooktop, oven vent areas and the oven door and oven window.

Important instruction for using the appliance

- Persons with a pacemaker or similar medical device should exercise caution using or standing near an induction unit while it is in operation as the electromagnetic field may affect the working of the pacemaker or similar medical device. It would be advisable to consult your doctor or the pacemaker or similar medical device manufacturer about your particular situation.
- **Storage In or On the Appliance -** Flammable materials should not be stored in the oven, near surface burners or elements, or in the storage or warmer drawer (if provided). This includes paper, plastic, and cloth items, such as cookbooks, plasticware and towels, as well as flammable liquids. Do not store explosives, such as aerosol cans, on or near the appliance.

Important Safety Instructions



- Do not leave children alone - Children should not be left alone or unattended in the area where appliance is in use. They should never be allowed to sit or stand on any part of the appliance, PIPPO including the storage drawer, lower broiler drawer, warmer drawer, or lower double oven.
- Do not store items of interest to children in the cabinets above the appliance or on the backguards of ranges. Children climbing on or near the appliance to reach items could be seriously injured.
- Do not allow children to climb or play around the appliance. The weight of a child on an open oven door may cause the appliance to tip, resulting in serious burns or other injury. An open drawer when hot may cause burns.
- Stepping, leaning, or sitting on the door or drawers of this appliance can result in serious injuries and also cause damage to the appliance.
- Never cover any slots, holes or passages in the oven bottom or cover and entire rack with materials such as aluminum foil. Aluminum foil linings may also trap heat, causing a fire hazard.
- When heating fat or grease, watch it closely. Grease may catch fire if it becomes too hot.
- Do not use water or flour on grease fires.
- Smother fire or flame or use dry chemical or foam-type extinguisher. Cover the fire with a pan lid or use baking soda.
- Only use dry potholders. Moist or damp potholders on hot surfaces may result in burns from steam. Do not let potholders touch hot heating elements or hot cooking areas. Do not use towels or other bulky cloths.
- Do not heat unopened food containers - Build-up of pressure may cause the container to burst and result in injury.
- Wear proper apparel - Loose-fitting or hanging garments should never be worn while using the appliance. Do not let clothing or other flammable materials come into contact with hot surfaces.
- Do not attempt to operate the appliance during a power failure. If the power fails, always turn off the appliance. If the appliance is not turned off, electric surface elements may resume operation when power is restored. Once the power is restored, reset the clock and the oven function.



Important Safety Instructions

- Never use your appliance for warming or heating the room.

Important instruction for using your induction cooktop

- Know which knob or key controls each surface heating area. Place the cookware containing food on the cooking area before turning it on. Turn the cooking area off before removing the cookware.
- Cookware handles should be turned inward and not extend over adjacent surface elements. — To reduce the risk of burns, ignition of flammable materials and spillage due to unintentional contact with the utensil, the handle of the cookware should be positioned so that it is turned inward and does not extend over other cooking areas.
- Use proper pan size — This appliance is equipped with one or more surface units of different sizes. Select cookware with flat bottoms that match the surface unit size. Using the proper cookware on the cooking area will improve efficiency.
- Glazed cooking utensils — Only certain types of cookware are suitable for cooktop service and must be magnetic in order to work properly on the induction zones. Check the manufacturer's recommendations for cooktop use to ensure that the cookware is compatible with induction cooking.
- Improper cookware may break due to sudden changes in temperature. Check the cookware manufacturer's recommendations for cooktop use.
- Do not place metallic objects such as knives, forks, spoons and lids on the cooktop surface since they can become hot.
- Never leave surface elements unattended. Boil-overs may cause smoking and greasy spills that may ignite. A pan that has boiled dry could be damaged and may damage the cooktop
- When you are flaming foods under a ventilating hood, turn on the fan.



Important instructions for glass and ceramic cooktops



WARNING

- Do Not Clean or Operate a Broken Cooktop. If cooktop should break, cleaning solutions and spillovers may penetrate the broken cooktop and create a risk of electric shock. Contact a qualified technician immediately.

Clean cooktop glass with caution. If a wet sponge or cloth is used to wipe spills on a hot cooking area, be careful to avoid steam burns. Some cleaners can produce harmful fumes if applied to a hot surface. Avoid scratching the cooktop glass with sharp objects.

Important instructions for using your oven

- Protective liners—Do not use aluminum foil, aftermarket oven liners, or any other materials or devices to line oven bottom, oven racks, or any other part of the appliance. Only use aluminum as recommended for baking, such as lining cookware or as a cover placed on food. Any other use of protective liners or aluminum foil may result in a risk of electric shock, fire or a short circuit.
- Take care when opening oven door, lower oven door, or warmer drawer (some models). Stand to the side of the appliance when opening the door of a hot oven. Let hot air or steam escape before you remove food or place it back in the oven.
- Keep oven vent ducts unobstructed. Touching surfaces in this area when the oven is on may cause severe burns. Do not place plastic or heat-sensitive items on or near the oven vent. These items can melt or ignite.
- Placement of oven racks - Always place oven racks in required position while the oven is cool. If a rack has to be moved while the oven is hot, do not let the potholder come into contact with a hot burner or element in oven. Use potholders and grasp the rack with both hands when repositioning it. Remove all cookware and utensils before moving the rack.
- Do not use a broiler pan without its insert.
- Broiler pans and inserts allow dripping fat to drain away from the high heat of the broiler. Do not cover the broiler insert with aluminum foil; exposed fat and grease could ignite.



Important Safety Instructions

- Do not cook food on the oven bottom.
- Always cook in proper cookware and always use the oven racks.
- Prevent aluminum foils and the temperature probe from contacting the heating elements.

Important instructions for cleaning your appliance



CAUTION

- Make sure all controls are turned off and that the appliance is cool before manually cleaning any part of the appliance. Cleaning a hot appliance can cause burns.
- Clean the appliance regularly to keep all parts free of grease that could catch fire. Do not allow grease to accumulate. Greasy deposits in the fan could catch fire.
- Always follow the manufacturer's recommended directions when using kitchen cleaners and aerosols. Be aware that excess residue from cleaners and aerosols may ignite causing damage and injury.
- Clean ventilating hoods frequently, grease should not be allowed to accumulate on hood or filter. Follow the manufacturer's instructions for cleaning ventilating hoods.

Important instruction for service and maintenance

- Do not repair or replace any part of the appliance unless specifically recommended in the manuals. All other servicing should be done only by a qualified technician. This reduces the risk of personal injury and damage to the appliance.
- Always contact your dealer, distributor, service agent, or manufacturer about problems or conditions you do not understand.
- Ask your dealer to recommend a qualified technician and an authorized repair service. Know how to disconnect the power to the appliance at the circuit breaker or fuse box in case of an emergency.
- Remove the oven door from any unused oven if it is to be stored or discarded.
- Do not touch a hot oven light bulb with a damp cloth. Doing so could cause the bulb to break. Handle halogen lights (if provided) with paper towels or soft gloves.
- Disconnect the appliance or shut off the power to the appliance before removing and replacing the bulb.

Important Safety Instructions



State of California Proposition 65



WARNING

Cancer or Reproductive Harm -
www.P65Warnings.ca.gov

Important: This appliance has been tested and found to comply with the limits for a class B digital device, pursuant to Part 18 of the FCC rules (United States) and ICES-001 (Canada). These limits are designed to provide reasonable protection against harmful interference in a residential installation. This unit uses and can radiate radio frequency energy that may interfere with radio communications if not installed and used in accordance with the instructions manual. However, there is no guarantee that interference will not occur in a particular installation. If this unit does cause interference to radio or television reception, which can be determined by turning the unit off and on, the user is encouraged to try to correct the interference by one or more of the following measures:

- Reorient or relocate the receiving antennae.
- Increase distance between unit and receiver.
- Connect the unit into an outlet or a circuit different from the one to which the receiver is connected.

How to read the user manual

This user manual uses the following reading conventions:

Instructions



General information on this user manual, on safety and final disposal.

Description



Description of the appliance and its accessories.

Use



Information on the use of the appliance and its accessories, cooking advice.

Cleaning and maintenance



Information for proper cleaning and maintenance of the appliance.



Safety instructions



Information/Advice

1. Use instruction sequence.
- Single use instructions.

SAVE THESE INSTRUCTIONS



Description

1 Description

1.1 General Description

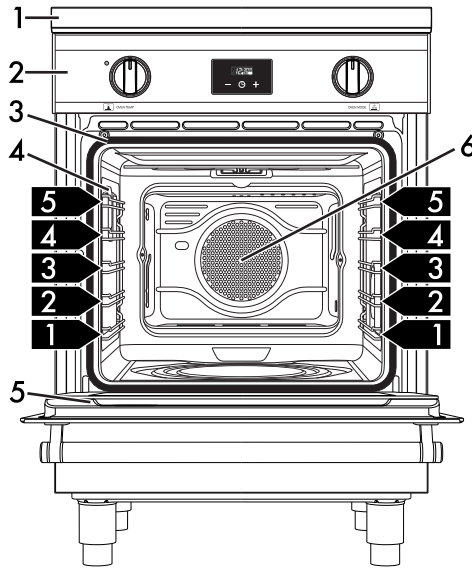

1 Cooktop

2 Control panel

3 Seal

4 Oven light

5 Door

6 Fan

1,2,3... Rack/tray support frame shelf

1.2 Control panel

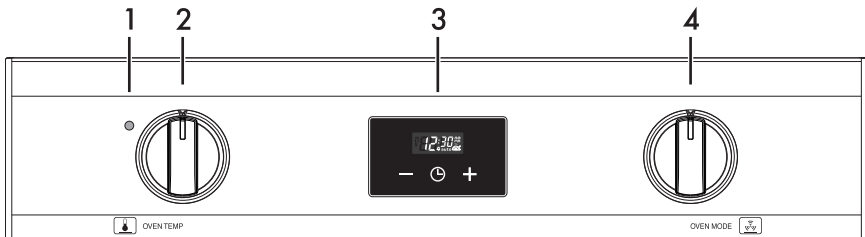

1 Pre-heating indicator light

The pre-heating indicator light comes on to indicate that the oven is pre-heating up. It turns off as soon as it reaches the set temperature.

It flashes regularly to indicate that the temperature set inside the oven is kept constant.



Description

Advantages of induction cooking



NOTE: The cooktop is equipped with an induction generator for each cooking zone. Each generator located under the glass ceramic cooking surface creates an electromagnetic field which induces a thermal current in the base of the pan. This means the heat is no longer transmitted from the hob to the pan but created directly inside the pan by the inductive current.

- Energy saving thanks to the direct transmission of energy to the pan (suitable magnetisable cookware is required) compared to traditional electric cooking.
- Improved safety as the energy is only transmitted to the pan placed on the cooktop.
- High level of energy transmitted from the induction cooking zone to the base of the pan.
- Rapid heating speed.
- Reduced danger of burns as the cooking surface is only heated under the base of the pan; foods which overflow do not stick.

1.4 Other parts

Shelves

The appliance features shelves to position trays and racks at different heights. The insertion heights are indicated from the bottom upwards (see 1.1 General Description).

Cooling fan

The fan cools the oven and comes into operation during cooking.

The fan causes a steady outflow of air that exits from the rear of the appliance, which may continue for a brief period of time even after the appliance has been turned off.

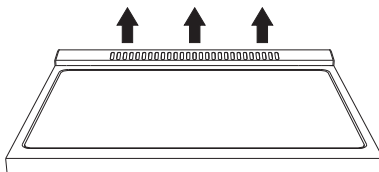

NOTE: Do not obstruct ventilation openings and heat dispersal slots.

Interior lighting

The appliance's interior lighting comes on:

- When the door is opened.
- When any function is selected.



NOTE: When the door is open, it is not possible to turn off the interior lighting.



1.5 Available accessories

Rack

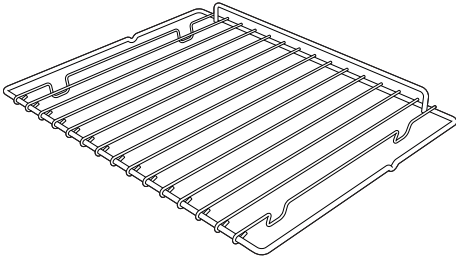

Used to hold containers containing food to be cooked.

Temperature probe



With the temperature probe, you can cook according to the temperature measured at the center of the food.

Protective cover

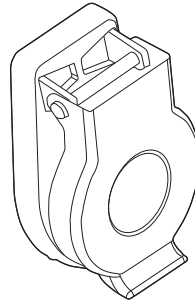

Used to cover and protect the temperature probe socket when the temperature probe is not in use.



NOTE: Some models are not provided with all accessories.



NOTE: The accessories intended to come into contact with food are made of materials that comply with the provisions of current legislation.



NOTE: Supplied and optional accessories can be requested to Authorized Assistance Centers. Use only original accessories supplied by the manufacturer.



2 Use

Instructions



High temperature inside the oven during use

Danger of burns

- Keep the oven door closed during cooking.
- Protect your hands by wearing oven gloves when moving food inside the oven.
- Do not touch the heating elements inside the oven.
- Do not pour water directly onto very hot trays.
- Keep children under the age of 8 away from the appliance when it is in use.
- If you need to move food or at the end of cooking, open the door 5 cm for a few seconds, let the steam come out, then open it fully.



High temperature inside the oven during use

Danger of fire or explosion

- Do not spray any spray products near the appliance.
- Do not use or leave flammable materials near the appliance or the storage compartment.
- Do not use plastic cookware or containers when cooking food.
- Do not put sealed tins or containers in the oven.
- Remove all trays and racks which are not required during cooking.



Improper use

Risk of damage to surfaces

- Do not cover the bottom of the oven cavity with aluminium or tin foil sheets.
- If you wish to use greaseproof paper, place it so that it will not interfere with the hot air circulation inside the oven.
- Do not place pans or trays directly on the bottom of the oven cavity.
- Do not use the open door to rest pans or trays on the internal glass pane.
- Do not pour water directly onto very hot trays.
- Cooking vessels or griddle plates should be placed inside the perimeter of the hob.
- All pans must have smooth, flat bottoms.
- If any liquid does boil over or spill, remove the excess from the hob.
- Use only pans with perfectly flat and smooth bases on the cooktop.
- Avoid letting heavy objects fall on the cooktop surface.
- In the case of cracks or fractures or if you cannot switch off the appliance, disconnect the power supply immediately and call Customer Service.
- Do not use the cooktop as a work surface.



High temperature Burn hazard

- Protect your hands with thermal gloves during use.
- Do not touch or clean the cooktop surface during operation or when the residual heat warning lights are on.
- Surface units may be hot even though they are dark in color.
- Do not place empty pots and pans on the cooking zones when they are switched on.
- Do not allow children of less than 8 years of age approach the appliance during operation.
- Enables the control lock in the presence of children or pets able to reach the cooktop.
- After use, turn off the cooking zones. They will remain hot for a certain period of time after switching them off. Do not touch the surfaces of the cooktop.
- Do not leave the appliance unattended during cooking operations that could release fats or oils.



High temperature inside the storage compartment Danger of burns

- Do not open the storage compartment when the appliance is on and still hot.
- The items inside the storage compartment could be very hot after using the appliance.

First-time use

1. Remove any protective film from the outside or inside of the appliance, including accessories.
2. Remove any labels (apart from the technical data plate) from the accessories and from the oven cavity.
3. Remove and wash all the appliance accessories (see 3 Cleaning and maintenance).
4. Heat the empty oven to the maximum temperature to burn off any residues left by the manufacturing process.

Sounds

The magnetic field over the induction cooking zone may cause cookware to vibrate, creating a buzzing or humming noise. These sounds are not unusual, especially at high settings.

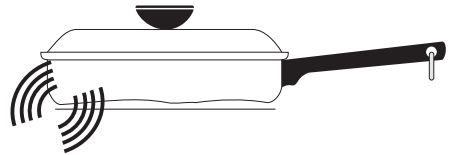

Cookware that is not perfectly flat on the bottom may vibrate slightly against the cooktop.

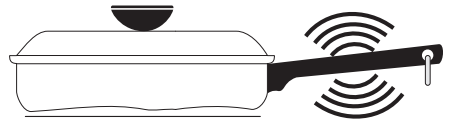

A loose handle may vibrate in its socket.

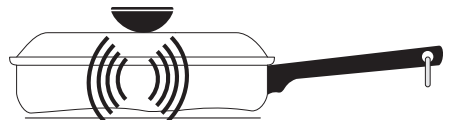

Multi-material cookware may allow small vibrations in its structure.



Use

Sounds are less likely to occur with heavier, higher quality cookware.

An induction cooktop may also produce faint clicking sounds from the electronic switches that maintain the desired cooking temperature. You may also hear a fan that cools the electronics inside the cooktop.

2.1 Using the accessories

Racks and trays

Racks and trays have to be inserted into the side guides until they come to a complete stop.

The mechanical safety locks that prevent the rack from being taken out accidentally have to face downwards and towards the oven back.

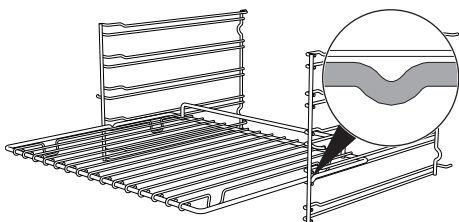

NOTE: Gently insert racks and trays into the oven until they come to a stop.



NOTE: Clean the trays before using them for the first time to remove any residues left by the manufacturing process.

2.2 Using the cooktop

Cookware type

Ideally, cookware should have a flat bottom, straight sides, a tight-fitting lid and medium-to-heavy thickness.

Rough cookware finishes may scratch the cooktop. Aluminum and copper may be used in cookware as a core material or for the base. However, when used as a base they can leave permanent marks on the cooktop or grates. Cookware properties are a factor in how quickly and evenly heat is distributed, which affects cooking results. A non-stick finish has the same characteristics as its base material. For example, a non-stick finish on aluminum cookware will take on the properties of aluminum.

Refer to the following chart as a guide to the physical properties of cookware.

Aluminum

- Heats quickly and evenly.
- Suitable for all types of cooking.
- Medium or heavy thickness is best for most cooking tasks.

Cast iron

- Heats slowly and evenly.
- Good for browning and frying.
- Maintains heat for slow cooking.

Ceramic or glass-ceramic

- Follow the manufacturer's instructions.
- Heats slowly but unevenly.
- Best results with low to medium heat settings.

Copper

- Heats very quickly and evenly.



Earthenware

- Follow the manufacturer's instructions.
- Use low heat settings.

Porcelain enameled steel or cast iron

- See stainless steel or cast iron.

Stainless steel

- Heats quickly but unevenly.
- Stainless steel cookware with an aluminum or copper core or bottom provides even heating.

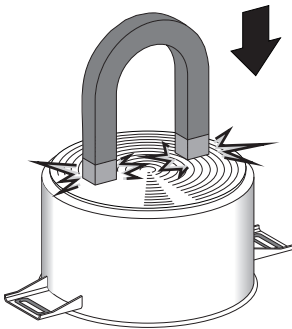

To see whether the pan is suitable, bring a magnet close to the bottom: if it is attracted, the pan is suitable for induction cooking. If you do not have a magnet, you can put a small amount of water in the pan, place it on a cooking zone and start the hot plate. If

the  symbol appears on the display, it means the pan is not suitable.



NOTE: Use only cookware with a perfectly flat bottom which is suitable for induction hot plates. Using cookware with an irregular bottom could jeopardise the efficiency of the heating system and prevent cookware from being detected on the hot plate.

Cookware recognition

When there is no saucepan on a cooking zone or if the saucepan is too small, no energy will be transmitted and the  symbol will appear on the display. If there is a suitable saucepan on the cooking zone, the recognition system detects it and switches on the cooktop to the power level set using the knob. Energy transmission is also interrupted when the saucepan is removed from the cooking zone (the  symbol will be shown on the display). If the cookware recognition function is activated in spite of the saucepan or frying pan on the cooking zone being smaller than the zone itself, only the necessary energy will be transmitted.

Pan diameters

Make sure that the minimum diameters of the pans are those indicated in the following table:

Zone	minimum \emptyset (cm - inches)	recommended \emptyset (cm - inches)
Zone 1 and 2 (single zone)	11 - 5"	18 - 7"
Zone 1 and 2 (Multizone)	19 - 8"	22 - 9"
Zone 3	13 - 5"	25 - 10"
Zone 4	9 - 4"	16 - 6"



Use

Bear in mind the following:

- Do not exceed the limits of the zones printed on the cooktop.
- Do not cover the control panel.
- Do not place the pans close to the edges of the glass.
- If you intend to use a griddle or a long pan in zones **1** and **2** in Multizone mode, it is recommended that you use one with a maximum size of 22 x 36 cm (9" x 36") and a minimum size of 19 x 19 cm (8" x 8").

Limiting the cooking duration

The hob has an automatic device which limits the duration of use. If the cooking zone settings are not changed, the maximum duration of operation for each zone depends on the power level selected. When the device for limiting the duration of use is activated, the cooking zone turns off, a short alert sounds and, if the zone is hot, the **H** symbol appears on the display.

Livello di potenza impostato	Durata massima della cottura in ore
1	6
2	6
3-4	5
5	4
6-7-8-9	1 ½

Protection from overheating

If the cooktop is used on full power for a long period, the electronics will have trouble cooling down if the room temperature is high. To avoid excessively high temperatures forming in the electronics, the power to the cooking zone is reduced automatically.

Advice on energy-saving

- The diameter of the base of the pan must correspond to the diameter of the cooking zone.



- When buying a pan, check whether the diameter indicated is that of the base or the top of the pan, as the top is almost always larger than the base.
- When preparing dishes with long cooking times, you can save time and energy by using a pressure cooker, which also helps to retain vitamins contained in the food.
- Make sure that the pressure cooker contains enough liquid as, if there is not enough and it overheats, this may cause damage to both the pressure cooker and the cooking zone.
- If possible, always cover pans with a suitable lid.



- Choose a pan suitable for the quantity of food to be cooked. A large, half-empty saucepan leads to a waste of energy.



NOTE: Under certain circumstances, if the cooktop and the oven are being used at the same time, the maximum power limit that can be used by the electrical system might be exceeded.

Induction cooktop control panel

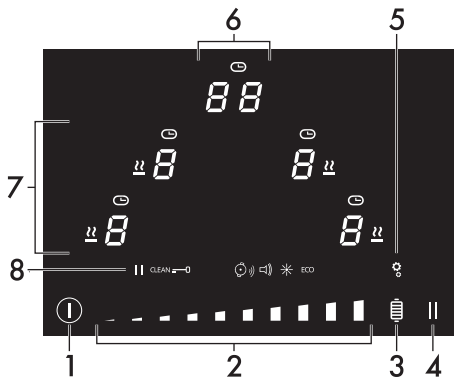





- On/Off button
- Scroll bar
- Grill function button
- Pause button
- Settings menu button
- Timer display
- Cooking zones display
- Settings icons

Switching on the cooktop for the first time



NOTE: When the appliance is first connected to the mains power supply, an automatic check is run and will turn on all the lights for a few moments.

When the appliance is used for the first time, after being connected to the mains, the flashing  symbol appears on the display. It is used to access the appliance's technical menu and is intended only for Technical Support personnel. Once the appliance has been switched on, the  icon, the dimmed  button and the text  appears on the timer display.

List of icons



Warming



Timer



Pause



Clean



Control lock



Automatic pan detection



Button volume



Display brightness







Eco mode



Use

List of buttons

-  On/Off button: turns the cooktop on or off.
-  Settings menu button: allows you to access the appliance's settings.
-  Grill function button: activates the Grill function.
-  Pause button: pauses the function on a specific cooking zone.



Scroll bar: increases or decreases the power level of a cooking zone; allows you to adjust settings and to select user menu options.

Cooking zones display



The buttons for selecting the cooking zones, the timer icons above each of them and the Warming function icons are located in this zone.

Timer display



The controls for setting the independent timer and the timer for the cooking zones are located in this area. When it is possible to set an independent timer, the text

 is displayed.

Overheating protection

If the cooktop is used on full power for a long time, it may be difficult for the electronics to cool down if the room temperature is high.

If the temperature of the internal electronic components exceeds the safety threshold, the appliance will switch off automatically

and the following symbols  -  - 

-  will be displayed in sequence (see 2.5 Error codes).



Energy saving tips

- The diameter of the base of the pan must not be greater than the width of the cooking zone printed on the cooktop.
- Pans must not be placed outside the perimeter of the cooktop or over the front control panel.
- When buying a pan, check whether the diameter indicated refers to the base or to the top of the pan, as the top is almost always larger than the base.
- When preparing dishes with long cooking times, you can save time and energy by using a pressure cooker, which also helps to retain vitamins contained in the food.
- Make sure that the pressure cooker contains enough liquid, as overheating caused by the lack of water could damage the pan and the cooking zone.
- If possible, always cover pans with a suitable lid.
- Choose the right pan for the quantity of food to be cooked. A large, half-empty pan wastes energy.



NOTE: Under certain circumstances, if the cooktop and an oven are used at the same time, the maximum power limit of your electrical system might be exceeded.

Power levels

The power of the cooking zone can be set to various levels. The table shows the levels suitable for various types of cooking.

Power level	Suitable for:
0	OFF position
1-2	Cooking small amounts of food (minimum power), reheating food, keeping small amounts of water boiling, and whipping egg yolk or butter sauces.
3-4	Cooking solid or liquid foods, keeping water boiling, defrosting frozen foods, making 2- or 3-egg omelets, fruit and vegetable dishes, various preparations.
5-6	Cooking large quantities of food, roasting larger portions, stewing meat, fish and vegetables, simmering food, making jams, etc.
7-8	Roasting meat or fish, sautéing steaks or liver with flour, browning meat and fish, eggs, etc.
9	Roasting, browning, cooking, etc.
P-P11	Deep-frying potatoes, etc., bringing water to boil quickly (maximum power)*.

* see Booster and Double Booster function





Switching the cooktop on and off

To activate the cooktop, keep the  On/Off button pressed in for at least 1 second. Press it again for at least one second to deactivate it.



NOTE: If a power level is not selected within a few seconds, the cooktop will be automatically deactivated.

- The  text appears on the timer display for a few seconds, during which an independent timer can be set (see "Minute timer").
- If a power limitation has been set, the number associated with the set power level will be displayed for a few seconds instead of the text . In this case, you can still set an independent timer by touching the timer display.

Automatic cooking zone activation



NOTE: The cooktop is fitted with an automatic pan detection system, indicated by the  icon. This function is enabled by default, but can be deactivated via the user menu.

After switching on the cooktop:

- Place a pan (suitable for induction cooking and not empty) on the cooking zone you wish to use.

- The button corresponding to the zone on which the pan has been placed turns on automatically and displays . The other zones cannot be activated.

If automatic pan detection is disabled, when the appliance is switched on, the  symbol appears on the displays of all the cooking zones. To activate the zones, select them via the relative display and then select the required power level.

Regulating the cooking zone

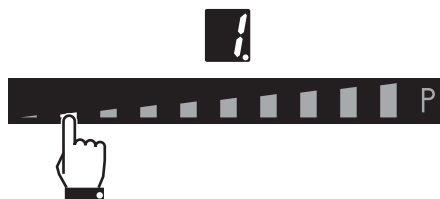

After selecting a cooking zone:

1. Place your finger on the left-hand side of the scroll bar of the cooking zone to be used.



The power level indicated is now .



2. Slide your finger to the left or right on the scroll bar to select the power level, between  and  or activate the Booster function  (see "Booster Function").

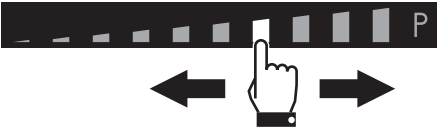

The display of the zone being used will indicate the power level selected.

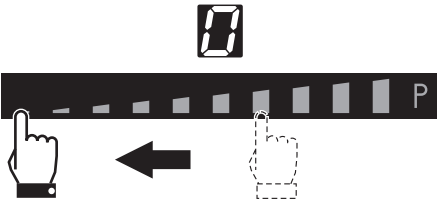

Switching off the cooking zone

1. Slide your finger all the way to the left on the scroll bar of the cooking zone you wish to turn off.



The display of the selected zone indicates



-  **NOTE:** Hold the  On/Off button down for at least 2 seconds to switch off all the cooking zones at the same time.

Quick selection



NOTE: This function allows you to set the cooking zones to the required power level quickly.

After switching on the cooktop and selecting a cooking zone:

- Place a finger at approximately the power level required on the scroll bar.



Booster Function



Improper use
Burn hazard

- Do not use the Booster and Double Booster functions to heat fats or oils as they could catch fire.



NOTE: Through this function, the maximum deliverable power of the cooking zone can be used, which is useful for bringing large amounts of water to a boil.



Use

After switching on the cooktop and selecting a cooking zone:

1. Place a finger on the left of the scroll bar.

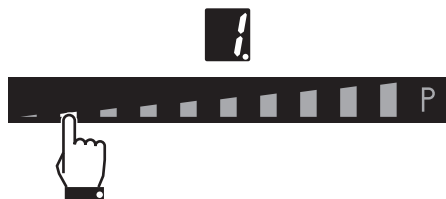

The display of the cooking zone used turns on: the power level indicated is

2. Move your finger to the right of the scroll bar to select the Booster function

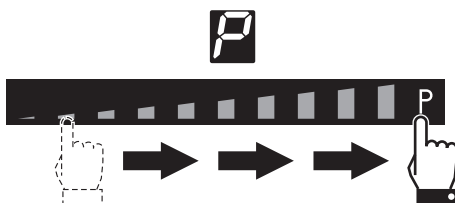

The display of the cooking zone used will show

The Booster function can be activated quickly.

- After switching on the cooktop and selecting a cooking zone, place a finger at the far right of the scroll bar of the cooking zone you wish to use (on the

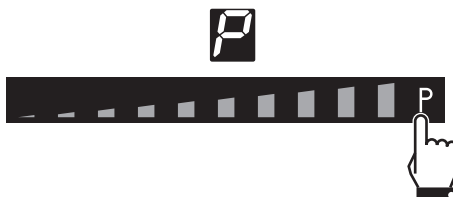

NOTE: The Booster function remains active for a maximum of 5 minutes, after which the power is reduced automatically to level



Double Booster Function

NOTE: There is no Double Booster Function in cooking zone **1** of the **30" (762 mm)** model.

The Double Booster function allows more power to be supplied than with the Booster function.

After activating the Booster function for a cooking zone, press the

far right of the scroll bar. The - - symbols will be displayed in sequence.



Multizone Function



NOTE: This function allows you to operate two cooking zones at the same time (front and rear) when using pans such as fish kettles or rectangular pans.

After switching on the cooktop:

1. Place a finger on the front left and rear left cooking zone buttons at the same time.

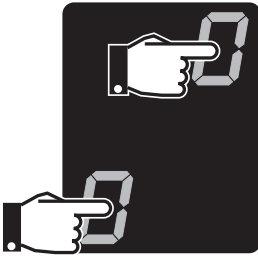

After a short beep, the  symbol will appear next to the button of the rear zone. The Multizone function is now active.



NOTE: The Multizone function can be activated automatically by placing a long pan on zones **1** and **2**.

2. Use the left-hand scroll bar to set the required cooking power.

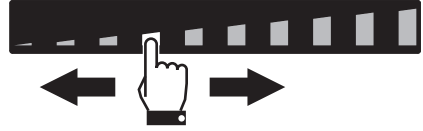

The same power level will be set for both cooking zones.



NOTE: It is only possible to activate the Multizone function using zones **1** and **2**.

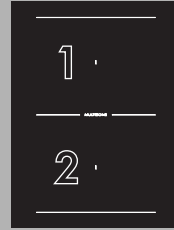

NOTE:

- This function automatically divides the power equally between both of the plates used.
- It is not possible to activate the Double Booster function for the cooking zones on which the Multizone function is active.



Use

If a large, oval or oblong pan is being used, make sure that it is placed in the center of the cooking zone.

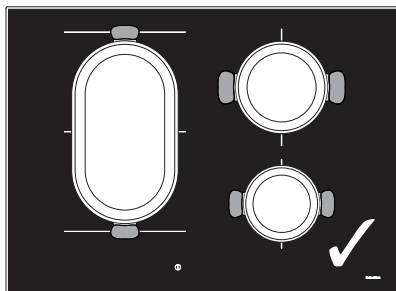

Example of correct pan position

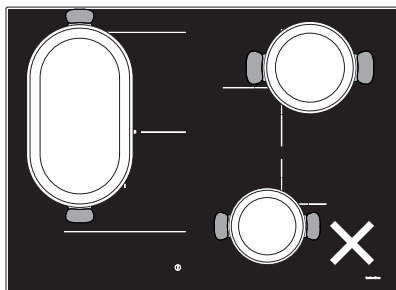

Example of incorrect pan position.

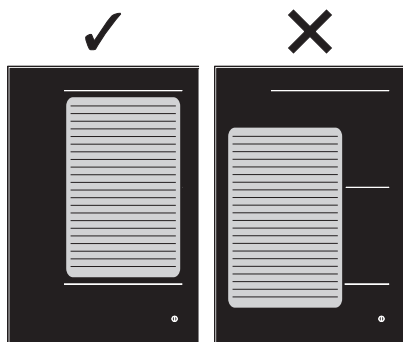

Examples of griddle position

To deactivate the Multizone function:

Press the buttons of the cooking zones on which the Multizone function is activated the same time. The symbol disappears and the two zones can be adjusted separately.

Residual heat indicator



Improper use
Burn hazard

- Supervise children carefully as they cannot easily see the residual heat indicator. In fact, even after being switched off, the cooking zone remains hot for a certain period of time. Make sure that children never touch the cooktop.

After a cooking zone has been switched off, each display shows a special symbol to indicate whether the zone is still hot, together with its approximate temperature:

if the temperature is between 60°C and 79°C.

if the temperature is between 80°C and 99°C.

if the temperature is 100°C or higher.

Rapid heating



NOTE: This function is not available for power level .



Booster and Double booster





The rapid heating function heats one cooking zone at maximum power for a limited time, after which it continues cooking at the set power level.

After selecting a cooking zone:

- Press and hold a power level (from  to ) for at least 3 seconds.

The  symbol appears on the cooking zone display.

After the heating time has elapsed, the cooking zone reverts to the previously selected power level.

This function can be deactivated by selecting a different power level or by switching the zone off.

Warming Function





NOTE: This function allows you to keep cooked food warm or to keep water boiling.

To activate the Warming function, turn on the cooktop and then:

1. Select a cooking zone.
2. Press the scroll bar between level **0** and level **1**.



3. The  symbol and the  icon appear on the cooking zone display.

To deactivate the Warming function:

1. Select the cooking zone on which the function is active.
2. Select another power level or switch off the zone.



Use

Minute timer



NOTE:

- This function is used to set a countdown timer that will emit a sound when the set time elapses.
- A minimum of 1 minute to a maximum of 99 minutes can be set.

After switching on the cooktop, without selecting a cooking zone:

1. Touch the inside of the timer setting area,

which displays

2. appears on the display and the

icon flashes.

3. Select the minutes using the scroll bar

(e.g.). If no selection has been made for a few seconds, a 5-minute timer can be started.

4. Once selected, the minutes digit flashes briefly and then the display allows you to

select tens of minutes ().

5. When the digit on the left stops flashing,

tens of minutes (e.g.) can be selected following the same procedure.

6. After a few seconds, the timer will start the countdown.
7. When the time elapses, a series of beeps will be emitted and the timer display will start to flash. Press the timer display to deactivate the alarm.



NOTE: The independent timer does not switch off the cooking zones; it only warns the user when the set number of minutes have elapsed.

Modifying and deactivating the minute timer



NOTE: If you modify a timer that has already been started, it has to be completely reset.

1. Use the button to activate the cooktop.
2. Press the timer display to reset the timer following the relative instructions.
3. To reset the timer, simply set both digits of the timer to zero.



Minute timer on cooking zones



NOTES: This function allows you to set additional independent timers at the same time, the number of which depends on the number of cooking zones available.

To activate additional minute timers after at least one cooking zone has been activated:

1. Select a power level.
2. Follow the same procedure as for an independent timer.

The  symbol appears above the cooking zone display to indicate that the zone is timed.

3. the timer will start a few seconds after the last selection was made.
4. When the time has elapsed, a series of beeps will be emitted; press the timer area to silence them.

Modifying and deactivating minute timer on cooking zones



1. Use the  button to activate the cooktop.
2. Select the cooking zone to modify.
3. Press the timer display to reset the countdown following the relative instructions.
4. To reset the timer, simply set both digits of the timer to zero.

Recall Function



NOTE: This function is used to restore some functions that have already been started after the appliance has been switched off unintentionally.

If the appliance has been switched off unintentionally, carry out the following procedure within 6 seconds:

1. Switch on the appliance.
 - The  icon starts to flash.
2. Immediately press the segment of the scroll bar directly below the  icon to restore the functions that were previously active.



NOTE: This function restores the cooking zones, timer and rapid heating functions. No other functions will be restored.



Use



Grill Function



NOTE: This function is used to automatically activate the Multizone function for the left zones only. It is used when using a griddle or cooking with long pans.

To activate the Grill function:

1. Place a griddle or a long pan on the left zones.
2. Press the  button.

The  symbol appears on the front zone display and the  symbol appears on the rear zone display. The scroll bar will be set automatically to level . (preheating stage)



After three minutes of operation, the power level will be reduced to level .

Press the  button and use the scroll bar to modify the power level at any time.

Press the  button to deactivate the Grill function..

2.3 Settings menu

The settings menu allows you to modify some of the operating characteristics of the appliance and allows you to.

With the appliance switched on, press the



button to access the settings menu.

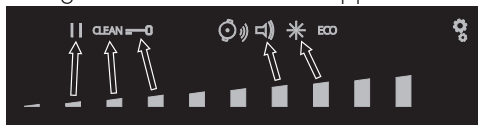

The scroll bar and the icons of all the settings that can be modified appear:



Individual settings can be selected by touching the segment of the scroll bar that is most directly underneath.

Press the  button again to exit from the menu.





NOTE: The  and  icons refer to functions that can only be modified via the user menu.

Pause function





NOTE: This function pauses the operation of all the cooking zones and the timer.

To activate the Pause function:

1. Switch on at least one cooking zone.
2. Access the settings menu.
3. Press the segment of the scroll bar below the  icon. The  symbol appears on the CLEAN zone displays.



To deactivate the Pause function:

1. Access the settings menu.
2. Press the segment of the scroll bar below the . The  symbols disappear and the appliance reverts to its previous functions.



NOTE:

- The cooking time limitation, the residual heat indicators and the control lock function remain enabled during the Pause function.
- The pause function can be maintained for a maximum of 10 minutes, after which the appliance switches off.
- When the power comes back on after a power failure, the pause function will be deactivated.

Clean Function



Improper use Burn hazard

- When this function is active, take extra care when removing dirt if the glass surface is hot.





NOTE: This function pauses the appliance for 15 seconds, during which it is possible to remove dirt or stains.

At least one cooking zone must be active in order for the Clean function to be used:

1. Access the settings menu.
2. Press the segment of the scroll bar below the  icon.
3. A 15-second countdown appears on the timer display, after which the appliance reverts to its previous functions.



Control lock





NOTE: This function allows you to disable all the buttons of the appliance, except for the  and  button.

This is useful when cleaning the appliance and to prevent functions being activated by mistake.

To activate the controls lock:

1. Access the settings menu.
2. Press the segment of the scroll bar below the  icon. The  symbol appears on the displays of all the cooking zones.

To deactivate the control lock:

1. Access the settings menu.
2. Press the segment of the scroll bar below the  icon. All the  symbols disappear.



Button sound volume



NOTE: Allows you to adjust the volume of the sounds associated with pressing the buttons.

1. Access the settings menu.
2. Press the segment of the scroll bar below the  icon.
3. Use the scroll bar to select the required volume.

Display lighting











NOTE: Allows you to adjust the general brightness of the displays.

1. Access the settings menu.
2. Press the segment of the scroll bar below the  icon.
3. Use the scroll bar to select the required level of brightness.





2.4 User menu

The user menu allows you to modify the operating characteristics of the appliance. Each option is indicated on the display with the letter  which alternates with a progressive number.

	Description
	(installers only)
	Option disabled
	Button volume
	Timer alarm volume
	Display brightness
	Timer animation
	Automatic pan detection
	Timer alarm duration



Accessing the user menu

1. If the cooktop is off, switch it on using the On/Off button .
2. Press  again within 3 seconds to switch it off; the  button starts to flash.
3. Press and hold .



NOTE: The  button continues to flash when you access the user menu.

4. The following appear on the cooking zone displays:





Press all the buttons of the cooking zones in sequence in a clockwise direction starting from the front left (1). Every effective touch will be confirmed by a beep.



NOTE: If the buttons are pressed in the incorrect order, the procedure for accessing the menu has to be repeated from step 3.

5. Release the button .

The user menu is active and the  symbol alternating with the number  will appear at the top of the cooking zones display.



NOTE: This option is restricted to the installer.

6. Press the  symbol to go back to selecting the options. The scroll bar appears in which each segment is associated with a menu option.
7. Press the segments of the scroll bar (except the first two) to select the available options.



NOTE: The first segment on the left (option ) is reserved for the power limitation procedure (installer only).



NOTE: For technical reasons, the second segment from the left (option ) is disabled. Selecting this option will have no effect.



NOTE: For each option, press the value symbol to activate the scroll bar in order to modify it.



Use

Option **02**





NOTE: Option **02** can also be modified via the settings menu (corresponding to ).

Modifies the volume of the button sounds.



NOTE: Depending on the adjustment range of each option, the scroll bar will show only those segments that correspond to the adjustments available for each option.



-  : minimum volume.
-  : maximum volume.



NOTE: The sound associated with the On/Off button  and the sounds associated with error messages cannot be deactivated.

Option **03**

Modifies volume of the sound signals when the timer has ended.



-  : minimum volume.
-  : maximum volume.

Option **04**



NOTE: Option **04** can also be modified via the settings menu (corresponding to ).

Modifies the brightness of the display.

-  : maximum brightness.
-  : minimum brightness.

Option **05**

Allows you to display the countdown of the minute timer and timed cooking in seconds, from 59 to 0 seconds.



NOTE: The second count is displayed when the timer is set for less than 10 minutes.

-  : animation off.
-  : animation on.



Option **U6**

Allows you to activate or deactivate the automatic pan detection function.

- **0**: automatic detection off.
- **1**: automatic detection on.



NOTE: If automatic pan detection is disabled, the zone has to be switched on manually when a pan is placed on the cooktop.

Option **U7**

Specifies the duration of the alarm when the timer has ended:

- **0**: alarm duration 120 seconds.
- **1**: alarm duration 10 seconds.
- **2**: alarm off.

Exiting the user menu

There are two ways to exit from the user menu:

1. Press the  button. Any modifications will be discarded and the cooktop will be switched off.

Or

2. Press and hold the On/Off button  for at least 2 seconds. The modifications will be saved and the cooktop will be switched off.

2.5 Error codes

If the appliance malfunctions or operates incorrectly, the associated error code appears on the displays of the cooking zones.

The error codes always start with **E** or **F** - **F**, followed by a number.

The following error codes can be corrected without having to contact the Technical Support Service.

- **E - F - 0 - 3**: Remove any materials or pans from the area around the front control panel.
- **E - 2**: Make sure that the pans are suitable for induction cooking and that they are not empty; allow the appliance to cool down.



NOTE: If these error codes appear frequently, contact Technical Support.

For all other errors, make a note of the code, if possible, and contact Technical Support.



2.6 Using the oven

To switch the oven on:

1. Select the cooking function using the function knob.
2. Select the temperature using the temperature knob.
3. If you wish, you can set the a timed cooking with the programmer clock. If you avoid using the programmer clock and thus setting a manual cooking you have to stop the oven manually by turning both the temperature and the function knobs to the **OFF** position.



NOTE: Ensure that the programmer clock shows the cooking duration symbol  otherwise it will not be possible to turn on the oven.

Press the key  to reset the programmer clock.

Functions list

BAKE

As the heat comes from above and below at the same time, this system is particularly suitable for certain types of food. Traditional cooking, also known as static cooking, is suitable for cooking just one dish at a time. Perfect for all types of roasts, bread and cakes, and in any case, particularly suitable for fatty meats such as goose and duck.

CONV BOTTOM

The combination of the fan with just the bottom heating element allows cooking to be completed more rapidly. This system is recommended for sterilizing or for finishing off the cooking of foods which are already well-cooked on the surface, but not inside, which therefore need a little more heat. Perfect for any type of food.

BROIL

Using the heat released from the central part of the broil element, this function allows you to grill small portions of meat and fish for making kebabs, toasted sandwiches and any types of grilled vegetable side dishes

BROIL MAX

The heat coming from the whole broil element gives perfect grilling results above all for thin and medium thickness meat and in combination with the rotisserie (where fitted) gives the food an even browning at the end of cooking. This function is perfect for sausages, ribs and ham. This function enables large quantities of food, particularly meat, to be grilled evenly.

CONV BROIL

The airflow produced by the fan softens the strong heatwave generated by the broil element, grilling perfectly even very thick foods. Perfect for large cuts of meat (e.g. shin of pork).



CONV BAKE

The operation of the fan, combined with traditional cooking, ensures consistent cooking even with complex recipes. Perfect for biscuits and cakes, even when simultaneously cooked on several levels. (For multiple-level cooking, we recommend using the 2nd and 4th shelves)

TRUE CONV

The combination of the fan and the circular heating element (incorporated in the rear of the oven) allows you to cook different foods on several levels, as long as they need the same temperatures and same type of cooking. Hot air circulation ensures instant and even distribution of heat. It will be possible, for instance, to cook fish, vegetables and biscuits simultaneously (on different levels) without odours and flavours mingling.

STEAM CLEAN

This function makes cleaning easier using the steam produced by a little quantity of water poured onto the appropriate groove placed on the bottom (see "Steam clean function").

DEFROST (Rapid)

Rapid defrost is assisted by the activation of a fan to ensure uniform distribution of room temperature air inside the oven. This function can be used for any type of food.



PIZZA

The operation of the fan, combined with the broil and the bottom heating element, ensures uniform cooking even with complex recipes. Perfect not just for pizzas, but also for biscuits and cakes

EN

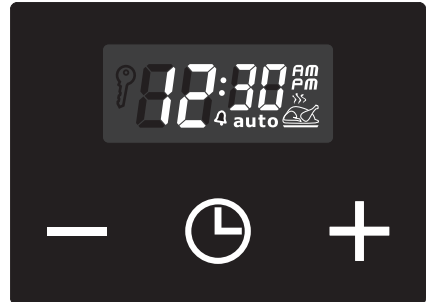
2.7 Programming clock



-  Value decrease key
-  Clock key
-  Value increase key



NOTE: Ensure that the programmer clock shows the cooking duration symbol  otherwise it will not be possible to turn on the oven.

Press the key  to reset the programmer clock.







Use

Setting the time





NOTE: If the time is not set, the oven will not switch on.

On the first use, or after a power failure, the digits  will be flashing on the appliance's display.

1. Keep the clock key  for two seconds. The dot between the hours and the minutes flashes.
2. The time can be set via the value increase key  and value decrease key . Keep the key pressed in to increase or decrease rapidly.
3. Wait 7 seconds. The dot between the hours and the minutes stops flashing.

The symbol  on the display indicates that the appliance is ready to start cooking.









NOTE: To change the time, hold down the value increase key  and value decrease key  at the same time for two seconds, then set the time.

Minute minder timer



NOTE: The minute minder timer does not stop the cooking operation but rather informs the user when the set time has run out.

The minute minder timer can be activated at any time.

1. Keep the clock key  pressed for a few seconds. The display shows the figures  and the symbol  flashing between the hours and minutes.
2. Use the value increase  and value decrease  keys to set the number of minutes required.
3. Wait approx. 5 seconds without pressing any key to finish setting the minute minder. The current time and the symbol  appear on the display.
4. A buzzer will sound when the set time is reached.
5. Press the value decrease key  to turn the buzzer off.











NOTE: The minute minder timer can be set from 1 minute to a maximum of 23 hours and 59 minutes.



Timed cooking



NOTE: Timed cooking is the function which allows a cooking operation to be started and then ended after a specific length of time set by the user.

1. Keep the clock key  pressed for a few seconds. The display shows the figures  and the symbol  flashing between the hours and minutes.
2. Press the clock key  again. On the display the digit  appear alternating with the digit  and the symbol  flashing under the minutes.
3. Use the value increase  and value decrease  keys to set the required minutes of cooking.
4. Select a function and a cooking temperature.

5. Wait approx. 5 seconds without pressing any key in order for the function to activate. The current time and the symbol **auto** will appear on the display.

At the end of cooking the heating elements will be deactivated. On the display, the symbol  turns off, the symbol



auto flashes and the buzzer sounds.

6. To turn the buzzer off, simply press one of the programmer clock keys.
7. Press the clock key  to reset the programmer clock.



NOTE: It is not possible to set a cooking time of more than 10 hours.



NOTE: To cancel the set programming press and hold down the value increase  and the value decrease  keys at the same time and then turn the oven off manually.



Use

Programmed cooking



NOTE: Programmed cooking is the function which allows a cooking operation to be started at a set time and then ended after a specific length of time set by the user.

1. Set the cooking time as described in the previous point "Timed cooking".
2. Press the clock key again. On the display the digit **End** appear alternating with the current time digit **11:30** and the symbol **auto** flashing under the minutes.
3. Use the value increase and value decrease to set the cooking end time.
4. Select a function and a cooking temperature.
5. Wait approx. 5 seconds without pressing any key in order for the function to activate. The current time and the symbol **auto** will appear on the display. The symbol disappear on the display.

At the end of cooking the heating elements will be deactivated. On the display, the symbol turns off, the symbol

auto flashes and the buzzer sounds.

6. To turn the buzzer off, simply press one of the programmer clock keys.

7. Press the clock key to reset the programmer clock.

12h or 24h format

The default mode is 12h format.

1. Keep the value increase key for a few seconds. The symbols **AM** or **PM** disappear on the display and 24h format is set.
2. Keep the value increase key for a few seconds to return in 12h format.

Selecting the buzzer

The buzzer can have 3 tones.

1. Hold down the value increase and value decrease keys at the same time.
2. Press the clock key . On the display the digit **ton2** appear.
3. Press the value decrease key to select a different buzzer tone

(**ton1** or **ton3**).



2.8 Using the temperature probe



High temperature of the temperature probe Danger of burns

- Do not touch the rod or the tip of the probe after having used it.
- Wear oven gloves when handling the temperature probe.



Improper use Risk of damage to surfaces

- Take care not to scratch or damage enamelled or chrome-plated surfaces with the tip or the plug of the temperature probe.



Improper use Risk of damage to the appliance

- Do not insert the probe into openings and slots on the appliance.
- When the probe is not in use, make sure that the protective cover is properly closed.



Improper use Risk of injury

- Do not leave the temperature probe unattended.
- Do not allow children to play with the probe.
- Take care not to injure yourself on the sharp parts of the probe.



Improper use Risk of damage to temperature probe

- Do not pull the cable to remove the probe from the socket or from the food.
- Make sure that the probe or its cable do not get caught in the door.
- No part of the probe should be allowed to come into contact with the walls of the oven cavity, the heating elements, the racks or the trays when they are still hot.
- When not in use, the probe should not be kept inside the appliance.
- Make sure the plug of the probe is fully inserted into the socket.
- Do not use the probe to place food into or to remove it from the oven cavity.

With the temperature probe, roasts, pork loin and various cuts and sizes of meat can be cooked to perfection.

The probe, in fact, allows foods to be cooked to perfection because it accurately monitors the core temperature of the food.

The core temperature of the food is measured by a sensor located in the tip of the probe.



Use

Positioning the probe

1. Place the food on a tray.
2. Insert the tip of the probe into the food before placing it in the oven.
3. For best results, make sure that the temperature probe is placed transversely in the thickest part of the food and for least 3/4 of its length. Make sure that it does not touch the tray underneath and that it does not protrude from the food.

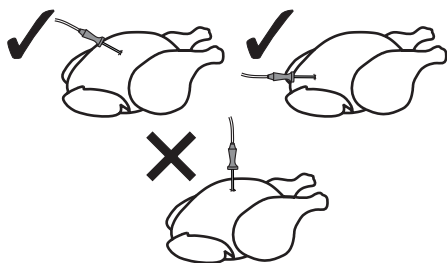

Cooking using the temperature probe

With preheating:

1. Set manual cooking (see "Using the oven").
2. After preheating, open the door and insert the tray onto which the food has been placed into the appropriate guides.
3. Insert the plug of the probe into the socket at the side, using the probe to open the cover.



High temperature inside the oven during use

Danger of burns

- Wear oven gloves when handling the temperature probe.







NOTE: In order for the probe to measure the core temperature of the food precisely, its tip must not be in contact with bones or fat.

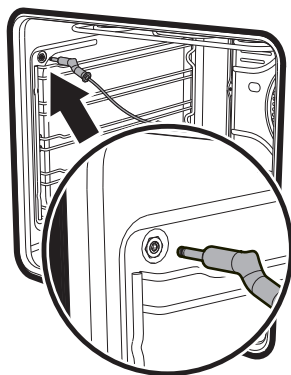

NOTE: The minimum recommended oven temperature when cooking using the probe is 250°F, unless slow cooking is used (see Chap. 2.7).







4. Close the door.
5. Press the clock key  for a few seconds; Press the clock key  again. The default target temperature 176°F (80°C) is indicated on the display and the **auto** symbol flashes.
6. Use the value increase  and value decrease  keys to regulate the target temperature to a value between the minimum and a maximum.

**NOTE:**

- **Minimum target temperature:** corresponds to the instantaneous temperature measured by the probe plus 35°F (2°C).
- **Maximum target temperature:** 210°F (99°C).

**NOTE:** If the value increase 

and value decrease  keys are not pressed within approximately 2 seconds, the display shows the actual temperature inside the oven.

7. Wait for a few seconds and then press the clock key  to display the instantaneous temperature measured by the probe.

Cooking will now continue until the instantaneous temperature measured by the probe is the same as the target temperature set by the user.



Without preheating:





1. Open the door.
2. Put the tray, on which the food has been placed with the probe in position, into the oven.
3. Insert the plug of the probe into the socket at the side, using the probe to open the cover.
4. Set the cooking using the probe as indicated in steps 5, 6 and 7 in the previous section.
5. Set manual cooking by selecting the temperature and cooking function (see "Using the oven").

When cooking with the temperature probe is in progress

NOTE: When the temperature probe is used, it is not possible to set programmed cooking or timed cooking.



NOTE: When cooking with the temperature probe is in progress, the value increase  and value decrease  keys are disabled.

1. Press and hold the clock key  to activate the minute minder timer; press the clock key  again to display the target temperature and use the value increase  and value decrease  keys to adjust it while cooking is in progress.
2. Press clock key  again or wait 5 seconds to return to cooking mode.



At the end of cooking

When the set target temperature for the temperature probe is reached, the heating elements are switched off and the appliance emits a series of beeps.

1. Press a button on the programmer clock to stop the buzzer.
2. Open the door.
3. Remove the probe from the food and unplug it from the socket.
4. Remove the food from the oven.
5. Make sure that the protective cover is properly closed.

2.9 Cooking advice

General advice

- Use pans/trays with a maximum width of 13-14" max.
- It is not possible to shorten cooking times by increasing the temperature (the food could be overcooked on the outside and undercooked on the inside).
- It is recommended to preheat the oven before baking.
- Using several ovens at the same time might affect the final cooking results.

Advice for cooking meat

- Cooking times vary according to the thickness and quality of the food and to consumer taste.
- Turn the food to brown both sides.
- Use a meat thermometer when roasting meat, or simply press on the roast with a spoon. If it is hard, it is ready; if not, it needs another few minutes cooking.

Advice for cooking with the Broiler

- Meat can be grilled even when it is put into a cold oven or into a preheated oven if you wish to change the effect of the cooking.
- When using the Broil function, preheat the oven for 15 minutes before cooking. Cooking times may vary depending on the thickness of the food.
- We recommend placing the food at the center of the rack.
- Foods should be seasoned before cooking. Foods should also be coated with oil or melted butter before cooking.
- Use the oven tray on the first bottom shelf to collect fluids produced by grilling.

Advice for cooking desserts and biscuits

- Temperature and cooking time depend on the quality and consistency of the dough.
- To check whether the dessert is cooked right through, at the end of the cooking time, put a toothpick into the highest point of the dessert. If the batter does not stick to the toothpick, the dessert is done.
- If the dessert collapses when it comes out of the oven, on the next occasion reduce the set temperature by about 50°F, selecting a longer cooking time if necessary.
- While cooking desserts or vegetables, excessive condensation may form on the glass. In order to avoid this, open the door very carefully a couple of times while cooking.



Tips for cooking on two shelves:

- Use a fan-assisted function to achieve uniform cooking at several levels. Use shelves 2 and 4.
- It is recommended to use 2 racks (can be requested from Authorized Assistance Centers).
- To facilitate the flow of air, place the molds/pans in the center of the racks and make sure that their width/diameter does not exceed 11".
- Position the racks keeping an empty level between them.
- Depending on the food and the increased load in the oven, cooking on two levels may take a few minutes longer than on a single shelf.
- The functions indicated for cooking on two shelves are the **CONV** functions.

Advice for defrosting and proving

- Place frozen foods without their packaging in a lidless container on the first shelf of the oven.
- Avoid overlapping the food.
- To defrost meat, use a rack placed on the second level and a tray on the first level. In this way, the liquid from the defrosting food drains away from the food.
- The tenderest parts of the food can be protected with aluminum foil.
- For successful rising, a container of water should be placed at the bottom of the oven.

To save energy

- Unless otherwise indicated on the packaging, defrost frozen food before placing it in the oven.
- In case of multiple cooking, it is advisable to cook the products one after the other to make the most of the already hot oven.
- Use preferably dark metal molds: they help to absorb the heat better.
- Remove all trays and racks which are not required during cooking.
- Stop cooking a few minutes before the time normally used. Cooking will continue for the remaining minutes with the heat that has accumulated inside the oven.
- Reduce any opening of the door to a minimum to avoid heat dispersal.
- Keep the inside of the appliance clean at all times.

Slow cooking with the probe

- This cooking mode is recommended for tender and lean meat whose core temperature should not exceed 65°C (149°F). Set the temperature of the oven to between 90° (194°F) and 100°C (212°F). This increases the cooking time, but maintains the quality of the food and prevents an excessive reduction in its volume.
- For a better result, before slow cooking, brown the meat in a pan over high heat for 1 or 2 minutes on each side.



Use

Cooking information table

Food	g	lbs	Recommended cooking mode	Temp. °F (°C)	Preheat	Number of racks	Rack position	Time (min)
Angel Cake	500	1,1	BAKE	350 (180)	Yes	Single	2	45-50
Angel Cake	500	1,1	CONV BAKE	350 (180)	Yes	Single	2	25-30
Sheet Cake	1400	2,8	CONV BAKE	320 (160)	Yes	Single	2	30-35
Apple Pie	-	-	BAKE	375 (190)	No	Single	2	55-60
Brownies	-	-	BAKE	350 (180)	Yes	Single	2	30-35
Chocolate Chip Cookies	-	-	BAKE	350 (180)	Yes	Single	2	15-20
Chocolate Chip Cookies	-	-	TRUE CONV	350 (180)	Yes	Multiple	2 & 4	10-15
Cookie Bars	-	-	CONV BAKE	350 (180)	Yes	Single	2	30-35
Sugar Cookies	-	-	BAKE	400 (200)	Yes	Single	2	9,10
Sugar Cookies	-	-	TRUE CONV	350 (180)	Yes	Single	2	10-11
Sugar Cookies	-	-	TRUE CONV	350 (180)	Yes	Multiple	2 & 4	10-11
Quiche	-	-	BAKE	400 (205)	Yes	Single	1	35-40
Vegetables	-	-	BAKE	500 (260)	Yes	Single	3	30-40
Baked Potatoes	600	1,3	BAKE	500 (260)	Yes	Single	3	40-45
Jam Tart	800	1,7	BAKE	375 (190)	Yes	Single	2	20,25
Frozen	-	-	BAKE	400 (200)	Yes	Single	2, 3	Package Time
Pecan	-	-	BAKE	350 (180)	Yes	Single	2, 3	45-50
Pumpkin Pie	900	2	BAKE	350 (180)	Yes	Single	1	45-50
Fresh	500	1,1	PIZZA	500 (260)	Yes	Single	1, 2	6,8
Thick Crust (frozen)	-	-	PIZZA	on package	Yes	3	on package	recipe time
Thin Crust (frozen)	-	-	PIZZA	on package	Yes	1,3	on package	recipe time
Biscuits	-	-	BAKE	350 (180)	Yes	Single	3	15-20
Biscuits	-	-	TRUE CONV	350 (180)	Yes	Multiple	2 & 4	15-20
Cup Cakes	-	-	BAKE	400 (205)	Yes	Single	2	18-20
Cup Cakes	-	-	TRUE CONV	350 (180)	Yes	Single	2	25-28
Cup Cakes	-	-	TRUE CONV	350 (180)	Yes	Multiple	2 & 4	26-28
Dinner Rolls	-	-	BAKE	350 (180)	Yes	Single	2	25-30
Dinner Rolls	-	-	TRUE CONV	350 (180)	Yes	Multiple	2 & 4	25-30
Bread	800	1,7	CONV BAKE	400 (205)	Yes	Single	2	35
Sweet Rolls	500	1,1	CONV BAKE	350 (180)	Yes	Single	2	15-20
Focaccia Bread	1000	2,2	BAKE	450 (230)	Yes	Single	2	20,25
Focaccia Bread	1000	2,2	CONV BAKE	400 (205)	Yes	Single	2	20,25

Use



Food	g	lbs	Recommended cooking mode	Temp. °F (°C)	Preheat	Doneness	Rack position	Time (min)
Hamburgers	140	0.3	CONV BROIL	500 (260)	No	Medium	4	Side 1: 9 Side 2: 5
Hamburgers	140	0.3	CONV BROIL	500 (260)	Yes	Medium	4	Side 1: 7 Side 2: 8
Tenderloin	1200	2,6	TRUE CONV	450 (230)	No	Rare Medium Well Done	2	44 52 60
Lamb Ribs	-	-	CONV BROIL	500 (260)	No	-	4	Side 1: 13 Side 2: 7
Chops	150	0.3	CONV BROIL	500 (260)	No	Well Done	4	Side 1: 10 Side 2: 4
Sausage	150	0.3	CONV BROIL	500 (260)	No	Well Done	4	Side 1: 12 Side 2: 6
Ribs	-	-	TRUE CONV	400 (205)	No	Well Done	2	110
Chicken Breast, Bone-in	700	1,5	CONV BROIL	450 (230)	No	-	3	Side 1: 25 Side 2: 20
Chicken Thighs, Bone-in	-	-	CONV BROIL	500 (260)	No	-	4	Side 1: 14 Side 2: 15
Fish Filets Salmon	600	1,3	BROIL	500 (260)	No	-	4	30
Whole Fish Bream	600	1,3	TRUE CONV	400 (205)	No	-	2	35

Probe-cooking information table

Food	g	lbs	Recommended cooking mode	Temp. °F (°C)	Internal Temp. °F (°C)	Doneness	Rack position
Roast Beef	2000	4,4	TRUE CONV	350 (180)	130 (54)	Medium	2
Loin Roast	2000	4,4	TRUE CONV	350 (180)	160 (71)	Medium	2
Tenderloin	450	1	TRUE CONV	450 (230)	158 (70)	Medium	2
Chicken Whole	1100	2,4	TRUE CONV	400 (205)	185 (85)	-	2
Turkey Breast	2250	5	TRUE CONV	350 (180)	185 (85)	-	2



Cleaning and Maintenance

3 Cleaning and maintenance

Instructions



WARNING

Electrical Shock Hazard

- Before servicing, disconnect the appliance from the power supply.



WARNING

Risk of damage to surfaces

Improper use

- Do not use steam jets to clean the appliance.
- Do not use cleaning products containing chlorine, ammonia or bleach on steel parts or parts with metallic finishes on the surface (e.g. anodizing, nickel- or chromium-plating).
- Do not use abrasive or corrosive detergents on glass parts (e.g. powder products, stain removers and metallic sponges).
- Do not use rough or abrasive materials or sharp metal scrapers.
- Keep cooktop area clear and free from combustible materials, gasoline other flammable vapors and liquids.
- Do not obstruct the flow of combustion and ventilation air.

Recommendations



NOTE: We recommend the use of cleaning products distributed by the manufacturer.

To keep the surfaces in good condition, they should be cleaned regularly after use. Let them cool first.

Regular daily cleaning

Always use only specific products that do not contain abrasives or chlorine-based acids.

Pour the product onto a damp cloth and wipe the surface, rinse thoroughly and dry with a soft cloth or a microfiber cloth.

Food stains or residues

Do not use metallic sponges or sharp scrapers as they will damage the surfaces. Use ordinary non-abrasive products with the aid of wooden or plastic utensils if necessary. Rinse thoroughly and dry with a soft cloth or a microfiber cloth.

Do not allow residues of sugary foods (such as jam) to set inside the oven. If allowed to set for too long, sugar residue could pit the enamel lining of the oven.



NOTE: After cleaning, dry the appliance thoroughly to prevent any water or detergent from interfering with its operation or creating unsightly marks.



3.1 Cleaning the cooktop

Cleaning the glass ceramic surface

Light coloured marks from pans with aluminium bases can be easily cleaned off with a cloth moistened in vinegar. After cooking, remove any burnt residues; rinse with water and dry thoroughly with a clean cloth.

Dirt which may have fallen on the hob while cleaning lettuce or potatoes can scratch the hob when moving pans.

Consequently, remove any dirt from the cooking surface immediately.

Changes in colour do not affect the operation and stability of the glass. These are not alterations to the material of the hob but just residues which have not been removed and have then carbonised.

Shiny surfaces can form due to the bases of pans, especially aluminium ones, rubbing on the surface, and due to the use of unsuitable detergents. They are difficult to remove using conventional cleaning products. It may be necessary to repeat the cleaning process several times. Use of corrosive detergents or rubbing of pan bases can wear away the decoration on the hob over time and contribute to the formation of stains.

Weekly cleaning

Clean and maintain the hob once a week using an ordinary glass ceramic cleaning product. Always follow the manufacturer's instructions. The silicon in these products creates a protective, water-repellent membrane which also resists dirt. All marks stay on the membrane and can therefore be removed easily. After cleaning, dry the surface with a clean cloth. Make sure that there is no detergent left on the cooking surface as it might undergo an aggressive reaction when heated up and could modify the structure of the cooking surface.

Knobs



NOTE: Do not use aggressive products containing alcohol or products for cleaning steel and glass when cleaning the knobs, as these products could cause permanent damage.

The knobs should be cleaned with a soft cloth dampened with lukewarm water, then dried carefully. They can be removed by pulling them out from their housings.



Cleaning and Maintenance

3.2 Cleaning the door

Removing the door

For easier cleaning it is recommended to remove the door and place it on a tea towel.

To remove the door proceed as follows:

1. Open the door completely and insert two pins into the holes on the hinges indicated in the figure.

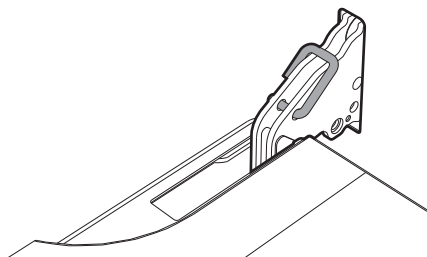

2. Grasp the door on both sides with both hands, lift it forming an angle of around 30° and remove it.

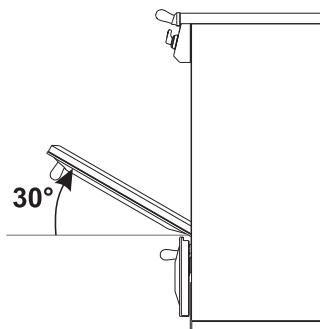

3. To reassemble the door, put the hinges in the relevant slots in the oven, making sure that grooved sections **A** are resting completely in the slots. Lower the door

and once it is in place remove the pins from the holes in the hinges.

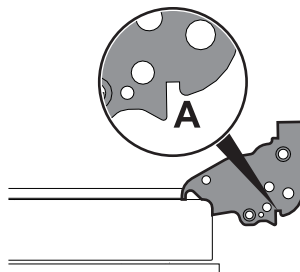

Cleaning the door glazing

The glass in the door should always be kept thoroughly clean. Use absorbent kitchen roll. In case of stubborn dirt, wash with a damp sponge and an ordinary detergent.

Removing the inner glass

To facilitate cleaning, the inner glass panels of the door can be removed.

1. Remove the inner glass panel by pulling it gently upward at the rear, moving it as indicated by the arrows (1).
2. Then pull the front part of the glass panel upwards (2). This way, the four pins attached to the glass panel are disengaged from their grooves in the door.

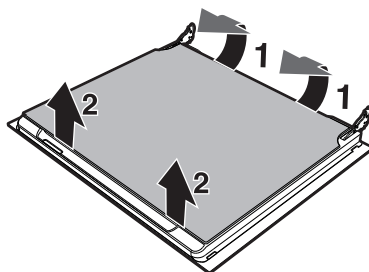



3. Remove the intermediate glass pane by lifting it upwards.

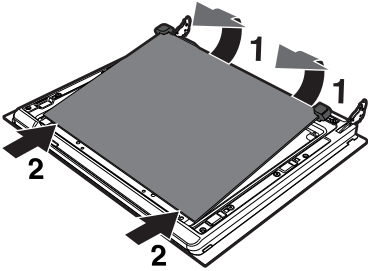

4. Clean the external glass panel and the one you just removed. Use paper towels. If there are tough to clean spots, use a damp sponge and mild detergent.

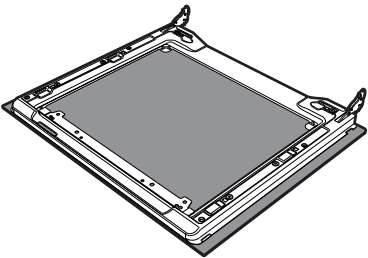

5. Reinsert the glass panels in the reverse order of removal.
6. Reposition the inner glass panel. Make sure you center and insert the four pins into their grooves in the door, using a little pressure.

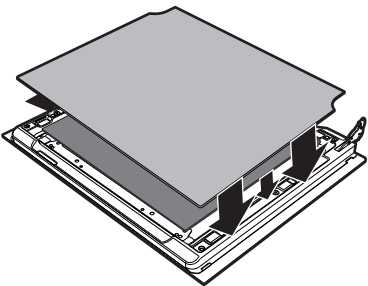

3.3 Cleaning the oven cavity

In order to keep your oven in the best possible condition, clean it regularly after letting it cool down.

Avoid letting food residue dry inside the oven cavity, as this could damage the enamel.

Take out all removable parts before cleaning.

For easier cleaning, we recommend removing:

- the door;
- the rack/tray support frames;
- removable guides, where fitted;
- the seal.



NOTE: In the event you are using specific cleaning products, we recommend running the oven at maximum temperature for 15-20 minutes in order to eliminate any residue.



Cleaning and Maintenance

Removal of the frame supports for racks/trays

Removing the guide frames makes it easier to clean the sides of the oven. This must be done each time you use the automatic cleaning cycle (only on some models).

To remove the guide frames:

- Pull the frame towards the inside of the oven to unhook it from its housing **A**, and then slide it out of the grooves at the back **B**.

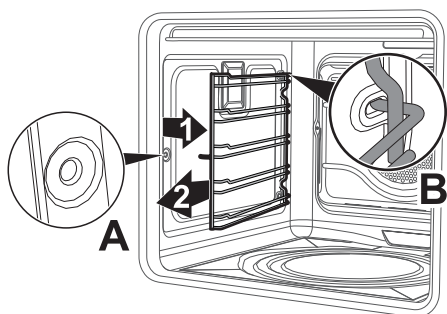

- When you have finished cleaning the oven, repeat the procedures indicated above to reposition the guide frames.

3.4 Steam clean function



CAUTION

Improper use

Risk of damaging the surfaces

- Remove any food residues or large spills from previous cooking operations from the inside of the oven.
- Carry out steam assisted oven cleaning operations only when the oven is cold.

Preliminary operations

Before starting the Steam clean function:

1. Completely remove all accessories from inside the oven. The upper guard can be left inside the oven.
2. Pour approximately 13.5 fl. oz. (400 cc - 1.7 cup) of water onto the bottom of the oven. Make sure it does not overflow out of the cavity.

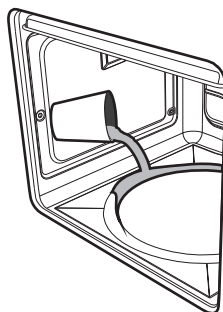



3. Spray a water and washing up liquid solution inside the oven using a spray nozzle. Direct the spray towards the side walls, upwards, downwards and towards the deflector.

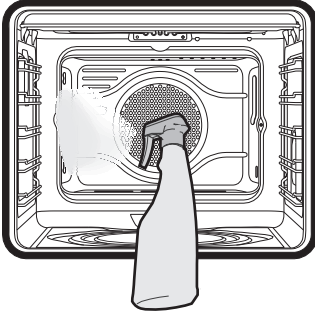

NOTE: We recommend spraying approx. 20 times at the most.

4. Close the door.

Steam clean settings

1. Turn the function knob to the **STEAM CLEAN** position and the temperature knob to 150°F (65°C).
2. Set a cooking time of 45 minutes using the programmer clock.
3. At the end of the cooking time, the timer will switch the oven heating elements off and the buzzer will start to sound.

End of the Steam clean function

1. Open the door and wipe away the less stubborn dirt with a damp cloth.
2. Use a non-scratch sponge with brass filaments to remove hard deposits.
3. In case of grease residues use specific oven cleaning products.
4. Remove the water left inside the oven.

For improved hygiene and to avoid food being affected by any unpleasant odours, we recommend that the oven is dried using a convection function at 300°F for approximately 10 minutes.

3.5 Extraordinary maintenance

Seal maintenance tips

The seal should be soft and elastic.

- To clean the seal, use a non-abrasive sponge and wash with lukewarm water.



Cleaning and Maintenance

Replacing the internal light bulb



WARNING

Danger of electrocution

- Unplug the appliance.
- Use protective gloves.



NOTE: The oven is fitted with two 40W light bulbs.

1. Completely remove all accessories from inside the oven.
2. Remove the rack/tray supports.
3. Use a tool (e.g. a spoon) to remove the bulb cover.

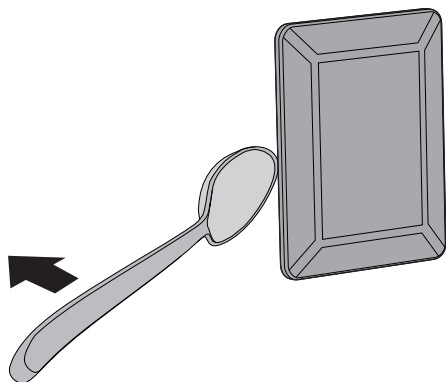

NOTE: Pay attention not to scratch the oven cavity enamel.

4. Loosen and remove the light bulb.

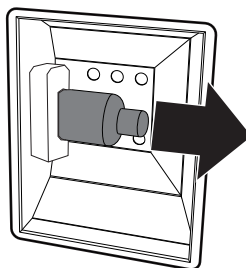

NOTE: Do not touch the halogen bulb with your fingers; cover it with an insulating cloth.

5. Replace the bulb with a similar one (40 W).
6. Reattach the cover. Leave the inside of the glass molding (**A**) facing the door.

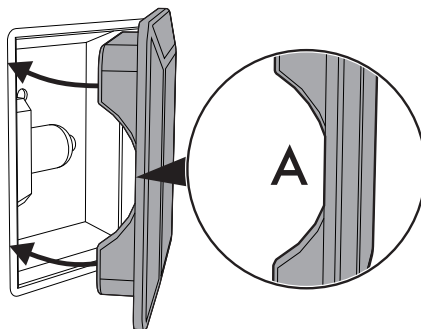

7. Press the cover firmly so that it adheres tightly to the light bulb holder.