

FC20UXDNE



| | |
|------------------------|---------------|
| Product family | Refrigerator |
| Installation | Free-standing |
| Category | Bottom mount |
| Reference width | Until 60 |
| Cooling type | No-frost |
| Defrost | Automatic |
| Hinge | Standard |
| Slot-in | Yes |
| Kitchen panel | Not supplied |
| Hinge position | Right |
| Reversible door | Yes |
| EAN code | 8017709312992 |



Aesthetic



| | | | |
|----------------------------------|------------------------|----------------------------------|---------|
| Aesthetics | Universal | Side color | Silver |
| Color | Stainless steel | Logo | Applied |
| Finishing | Fingerprint-proof | Door shelf profile color | White |
| Material | Stainless steel effect | Glass shelf profile color | Silver |
| Door stainless steel type | Fingerprint-proof | Display | LED |
| Handle | External | Display position | On door |
| Side material | Steel | | |

Refrigerator compartment features



| | | | |
|---|-----------------|------------------------------------|-----|
| No. of adjustable shelves | 3 | Bottle shelf | Yes |
| Number of fruit and vegetables drawers | 1 | Low temperature compartment | Yes |
| Type of adjustable shelves | Glass | Refrigerator lighting | LED |
| Crisper drawer type | Sliding crisper | | |

Refrigerator Inner Door

| | | | |
|--|---|------------------------------|---|
| Number of adjustable door shelves | 3 | No. of bottle shelves | 1 |
|--|---|------------------------------|---|

Other Refrigerator features



Accessories

Egg tray

MultiFlow

Yes

Freezer features

Number of drawers 3

Other technical features



Display functions

Fast-freezing, ECO

Temperature alarm

Yes

Door open alarm

Yes

Temperature setting type

Electronic

No. of compressors

1

Refrigerant gas type

R600a

Compressor type

Standard

Refrigerant quantity

1.1 oz

Foam agent

Cyclopentane

Performance / Energy Label NEW

Noise level 38 dB(A) re 1pW

Electrical Connection

Plug (F;E) Schuko

Frequency (Hz)

60 Hz

Current 10 A







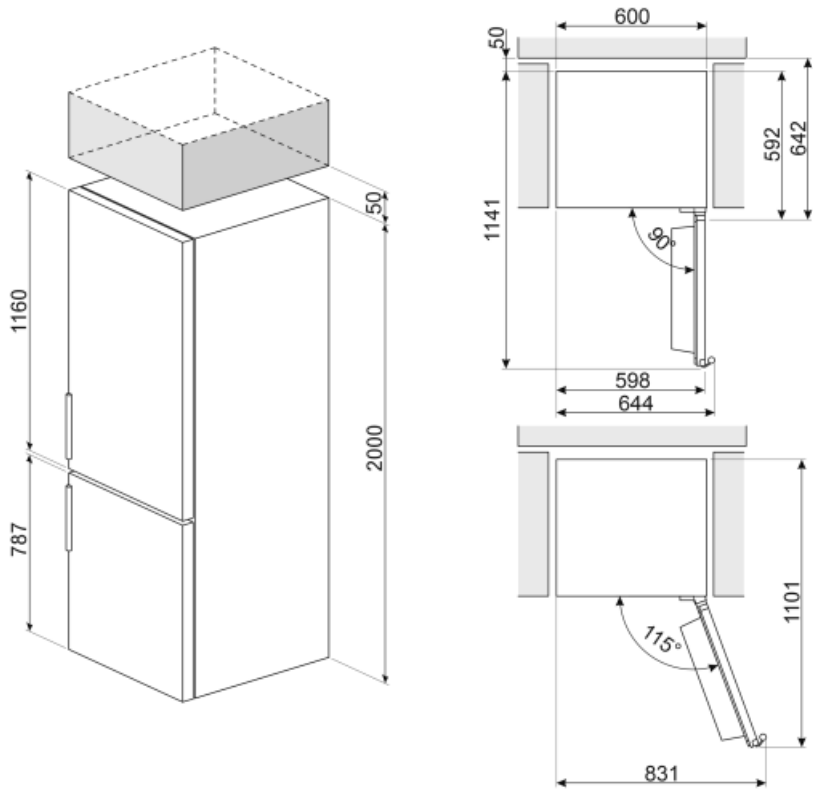

Power cord length

74 13/16 "

Voltage (V) 120 V



Symbols glossary (TT)

| | | | |
|--|--|---|--|
|  | The automatic defrost system works by automatically defrosting at regular intervals eliminating the need to defrost altogether. |  | LED display: to show programmes, functions and options selected and the time to the end of the cycle. |
|  | Economical mode: Analyzes fridge functioning during the activation and optimizes the operating cycle in order to reduce power consumption. |  | Fast freezing: The fast freezing function brings the temperature of the compartment down when activated a few hours prior to usage. |
|  | Fingerprint proof stainless steel: Fingerprint proof stainless steel keeps stainless steel looking as good as new. |  | LED interior lighting: is a more energy efficient and long lasting way of illuminating the interior of the appliance. |
|  | Air plus: keeps food fresher for longer. |  | Slot-in: The refrigerators with Slot-in opening can be perfectly integrated into the furniture structure, as the doors open at 90° do not go beyond the side of the product. In case of installation next to the wall, it will be necessary to consider the dimensions of the handle in order to open the door at 90°. |