

LIEBHERR

Use and Care Manual

Freezer

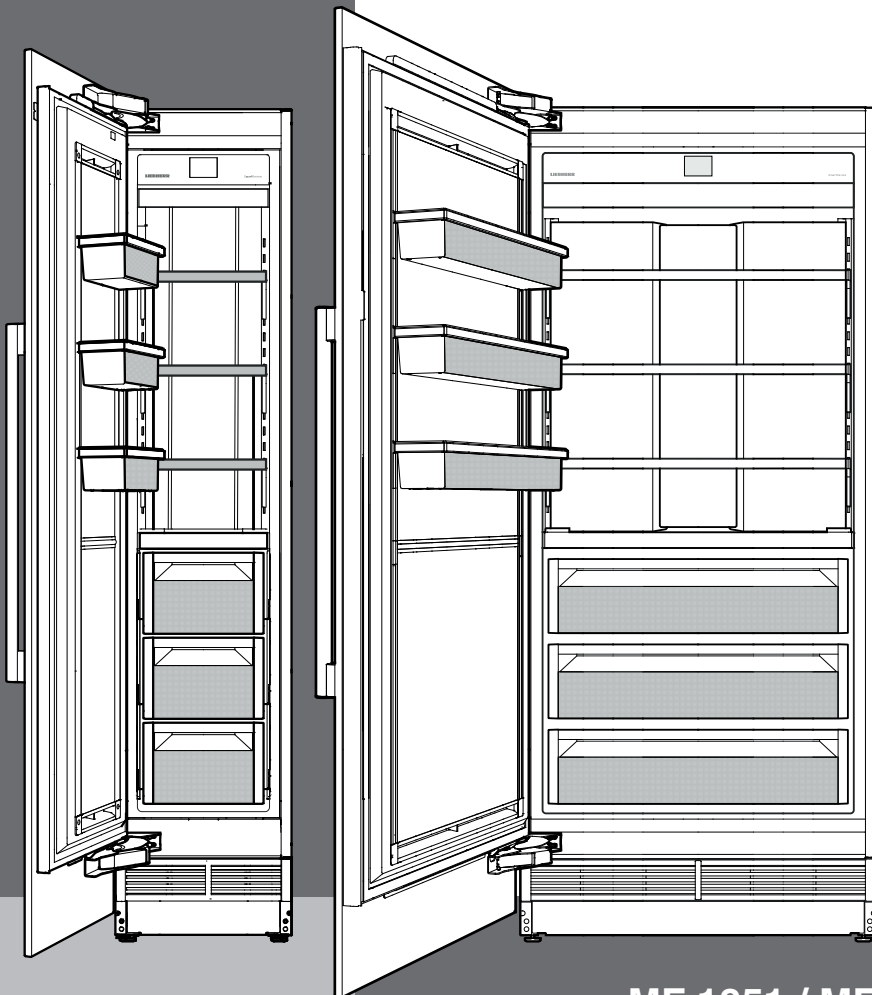

MF 1851 / MF 2451 / MF 3051 / MF 3651
7085 107-02

TABLE OF CONTENTS

Table of Contents	Page
Please Read and Follow these Instructions.....	2
California Proposition 65	3
Disposal of Old Appliance	3
Disposal of this Appliance	3
Disposal of Packaging Material.....	3
Important Safety Information	4
R600a Refrigerant	4
Electrical Safety	5
Safety Regulations.....	5
Description of the Appliance	6
Control Panel	7
Switching the Appliance On	7
Changing Language and Temperature Unit.....	7
Main Menu	8
Setting the Temperature	8
SuperFrost	9
Freezing and Storage	9
Safety Instructions and Warnings for the Ice Maker ...	10
Ice Maker Description	10
Switching the IceMaker on	10
Switching the IceMaker to Maximum Ice Production ..	11
PartyMode.....	11
SabbathMode.....	12
Switching the Appliance Off	12
Maintenance Message	13
Maintenance Confirmation.....	13
Setup Menu.....	14
SmartDeviceBox	15
Description of the SmartDevice Displays.....	15
Alarm Messages	16
Equipment	17
Interior Light	17
Cleaning	18
Maintenance Menu	19
Maintenance	20
Additional Functions	21
Troubleshooting	25
Customer Service	25
Appliance Information.....	25
LIEBHERR WARRANTY PLAN.....	26

Please Read and Follow these Instructions

These instructions contain Danger, Warning and Caution notes.

This information is important for safe and efficient installation and operation.

Always read and comply with all Danger, Warning and Caution notes!

DANGER!

Danger indicates a hazard which will cause serious injury or death if precautions are not followed.

WARNING!

Warning indicates a potentially hazardous situation which, if not avoided, could result in death or serious injury.

CAUTION!

Caution indicates a potentially hazardous situation which, if not avoided, may result in minor or moderate injury.

IMPORTANT

This indicates information that is especially relevant to a problem-free installation and operation.

IMPORTANT

All types and models are subject to continuous improvement. The manufacturer reserves the right to make modifications to the shape, equipment and technology.

California Proposition 65

- This product contains chemicals known to the state of California to cause cancer or reproductive harm.
- This product can expose you to chemicals including Diisononyl Phthalate (DINP) which is known to the State of California to cause cancer. For more information go to www.P65Warnings.ca.gov.
- This product can expose you to chemicals including Diisodecyl Phthalate (DIDP) which is known to the State of California to cause birth defects or other reproductive harm. For more information go to www.P65Warnings.ca.gov.

Disposal of Old Appliance



Risk of child entrapment.

Child entrapment and suffocation are not problems of the past.

Junked or abandoned refrigerators are still dangerous – even if they will sit for “just a few days.”

If you are getting rid of your old refrigerator, please follow these instructions to help prevent accidents.

Before you discard old appliances:

- **Take off the doors.**
- **Leave the shelves in place so that children may not easily climb inside.**
- **Cut off the power cable from the discarded appliance. Discard separately from the appliance.**
- **Be sure to follow your local requirements for disposal of appliances.**

Contact the trash collection agency in your area for additional information.

Disposal of this Appliance

This appliance contains flammable gases within the refrigeration circuit and insulation foam.

Contact the municipality or disposal company in your area for information on approved recycling or disposal.



This label or a similar one can be located on the rear of the appliance. It refers to the foamed-in panels in the door and/or the housing. This notice only applies for recycling. Do not remove the label.

Disposal of Packaging Material

The packaging is designed to protect the appliance and individual components during transport and is made of recyclable materials.



Keep packaging materials away from children. Polythene sheets and bags can cause suffocation!

If possible, please recycle packaging material at a recycling facility.

Important Safety Information

- Disconnect the appliance from the power source if a fault occurs. Pull out the plug, turn off or disable the power source.
- When disconnecting the appliance, always pull it out by the plug; never pull on the cable.
- Any repairs and work on the appliance should only be performed by the customer service department. Unauthorized work may be dangerous to the user. The power source cable should only be changed or replaced by the customer service department.
- Do not consume food which has been stored for too long; it could cause food poisoning.
- Do not store explosive substances such as aerosol cans with a flammable propellant in this appliance. Electrical components might cause leaking gas to ignite. You can identify such sprays by the printed contents or a flame symbol.
- Do not allow children to play with the appliance. Children must not climb, sit or stand on the shelves, drawers or door.
- To prevent possible injury due to an electrical shock, be sure to disconnect the power cord or turn off the circuit breaker before cleaning the appliance.
- To avoid injury or damage to the appliance, do not use steam cleaning equipment to clean the appliance.
- Do not operate the appliance in the presence of explosive fumes.
- In the event of a power outage, open the door as infrequently as possible.

- This appliance is not intended for use by persons (including children) with reduced physical, sensory or mental capabilities or lack of experience and knowledge unless they have been given initial supervision or instruction concerning use of the appliance by a person responsible for their safety. Children should be supervised to ensure that they do not play with the appliance.

R600a Refrigerant



The refrigerant R600a contained within the appliance is environmentally friendly, but flammable. Leaking refrigerant can ignite.

To prevent possible ignition, follow the warnings below:

- **Keep ventilation openings, in the appliance enclosure or in the built-in structure, clear of obstruction.** 
- **Do not use mechanical devices or other means to accelerate the defrosting process, other than those recommended by the manufacturer.**
- **Do not damage the refrigerant circuit.**
- **Component parts and power cords shall be replaced with like components performed by factory authorized service personnel only.**
- **Do not use electrical appliances inside the food storage compartments of the appliance, unless they are of the type recommended by the manufacturer.**

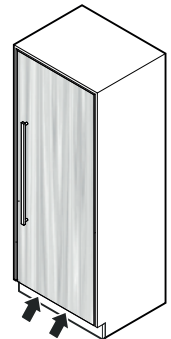

Electrical Safety

Connect this appliance to a 15 amp or 20 amp, 110-120 VAC, circuit which is grounded and protected by a circuit breaker or fuse.

We recommend using a dedicated circuit for this appliance to prevent circuit overload and the chance of interruption to the appliance.

This appliance is equipped with a three-prong (grounding) polarized plug for your protection against possible shock hazards.

Where a two-prong wall receptacle is encountered, contact a qualified electrician and have it replaced with a properly grounded three-prong receptacle in accordance with all local codes and ordinances.



WARNING!

Electrocution hazard.

Electrical grounding required.

- Do not remove the round grounding prong from the plug. →
- Do not use extension cords or ungrounded (two prong) adapters.
- Do not use a power cord that is frayed or damaged.

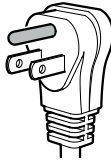

- Do not use a power strip. →

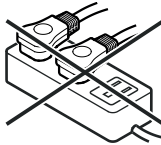

Failure to follow these instructions may result in fire, electrical shock or death.

Safety Regulations

This appliance is intended to be used in household and similar applications.

This includes, for example, use

- in staff kitchenettes, bed and breakfast establishments,
- by guests in cottages, hotels, motels and other forms of accommodation,
- in catering and similar services in the wholesale trade.

IMPORTANT

The appliance is not intended for outdoor use.

The appliance is manufactured to operate within specific ambient temperature limits according to its climate rating.

The climate rating indicates the ambient temperature at which the appliance may be operated in order to achieve full refrigeration performance.

Climate Rating

SN-T

Ambient Temperature

50°F to 109°F (10°C to 43°C)

IMPORTANT

Do not operate the appliance outside the specified ambient temperature range.

- The refrigerant circuit has been tested for leaks.
- The appliance complies with current safety regulations

CAN/CSA C22.2 No.60335-1-11

UL 60335-1 Fifth Edition

CAN/CSA C22.2 No. 60335-2-24:17

UL 60335-2-24 Ed.2

We recommend cleaning the appliance before turning it on for the first time. See **Cleaning**.

Turn on the appliance several hours before loading it.



WARNING!

Do not allow children to play with the appliance. Children must not climb, sit or stand on the racks or door.

Failure to follow these instructions may result in death or serious injury.

Description of the Appliance

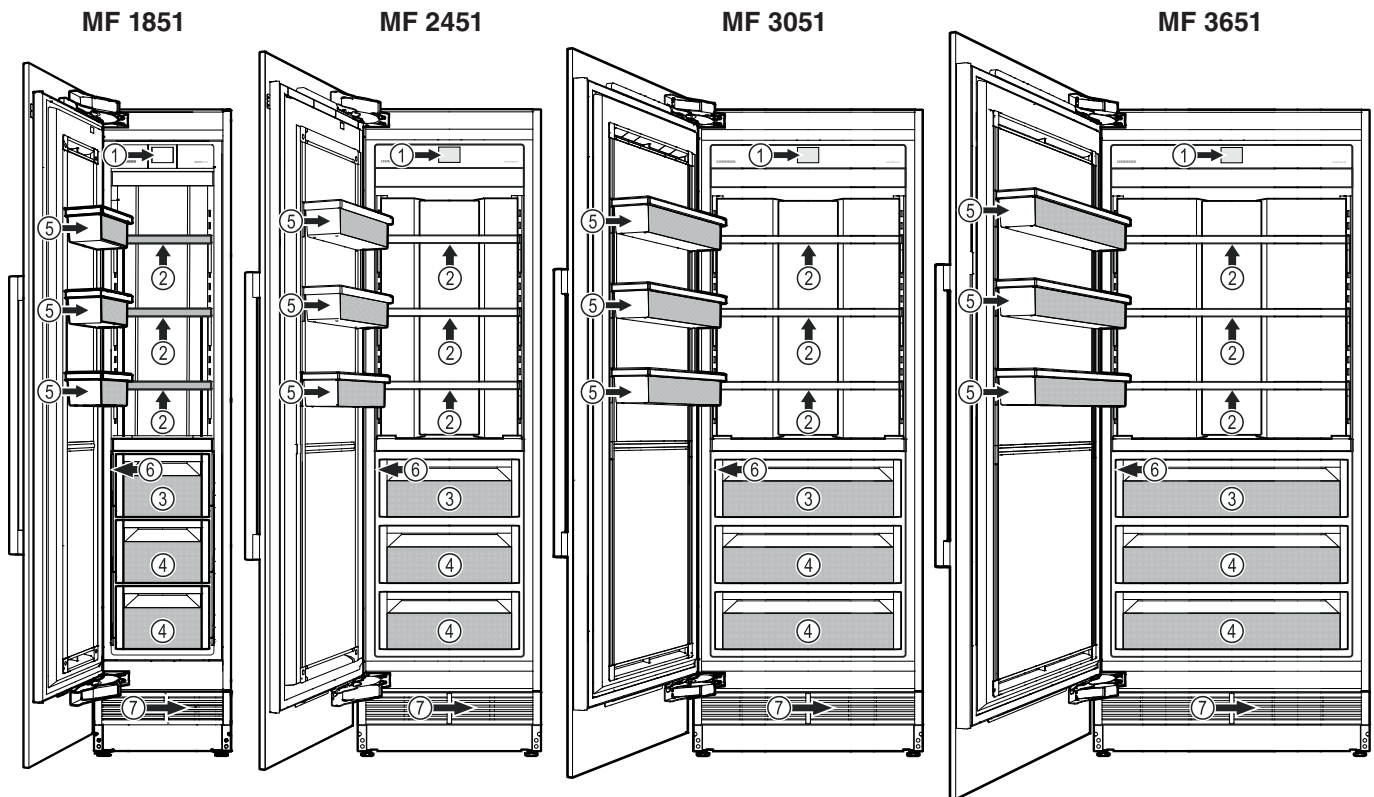

- (1) Control panel
- (2) Adjustable shelves
- (3) Ice maker (in the interior of the drawer)
- (4) Freezer drawer
- (5) Adjustable door rack
- (6) Model plate (behind the drawer on the left-hand side)
- (7) Water filter (behind the ventilation grille)

Control Panel

Three different actions to operate the control panel.

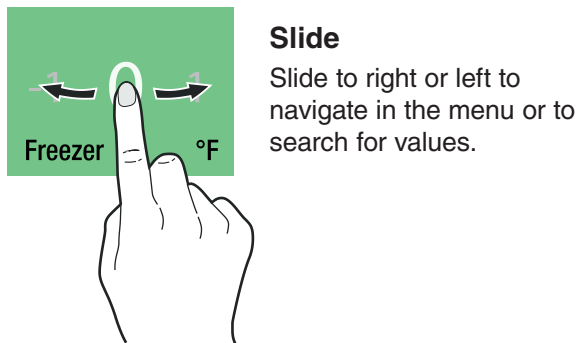
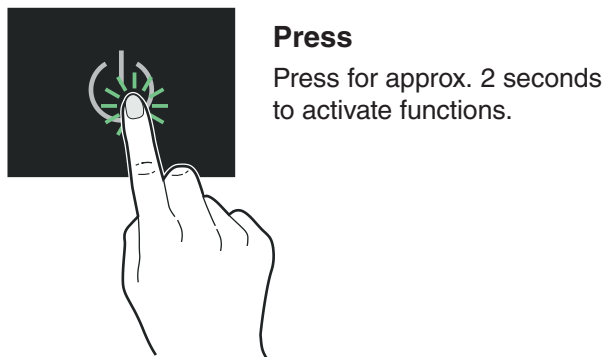
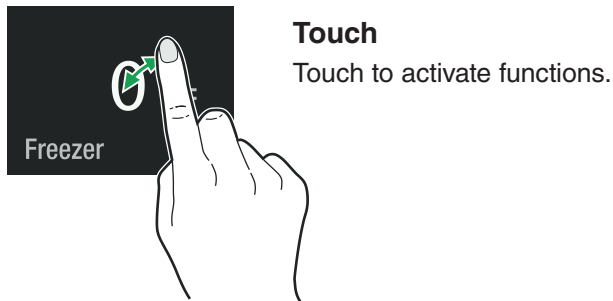

Switching the Appliance On

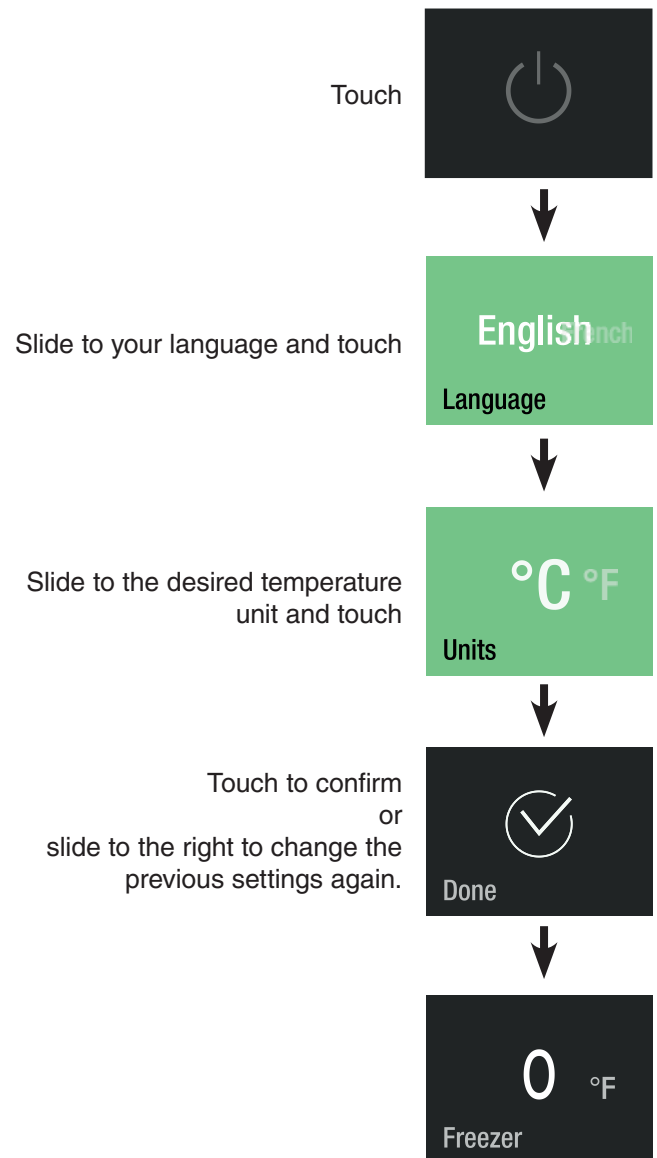







Changing Language and Temperature Unit

For future changes of language and temperature unit the appliance must be switched off and on again (customer settings will not be deleted).

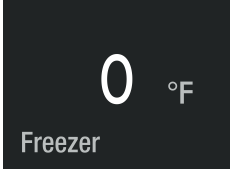
OPERATION

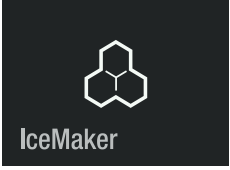
Main Menu

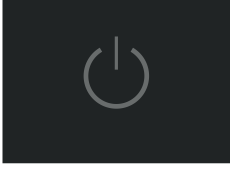
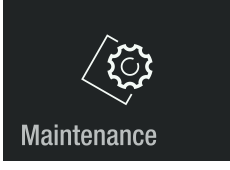
Slide through the main menu. The following functions are available.

 <p>Freezer</p>	Freezer compartment temperature display and temperature setting.
 <p>SuperFrost</p>	To freeze fresh food as rapidly as possible to ensure that the nutritional value, appearance and flavor of the food remains intact.
 <p>IceMaker</p>	To switch the IceMaker on or off and to maximum ice production.
 <p>PartyMode</p>	For permanent maximum cooling.
 <p>SabbathMode</p>	Appliance operating mode for Sabbath and holidays. Complies with STAR-K Kosher Certification.
 <p></p>	Switching the appliance on or off.
 <p>Maintenance</p>	Describes how to change the filters and clean the dust filter.
 <p>Setup</p>	Allows the adjustment of display brightness and includes the appliance information (service number, model name, serial number).

Setting the Temperature

Standard setting is 0°F.

Touch 

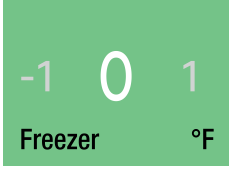
Slide to the desired target temperature and touch. 

The number flashing at the bottom right shows the actual interior temperature. It disappears when the target temperature is reached. 

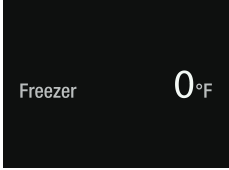
Close the appliance door. 

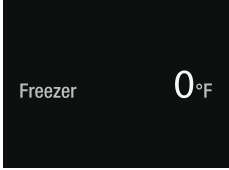
Display when the door is opened again. 

The temperature display blinks if the actual interior temperature is different to the target temperature. It stops blinking when the target temperature is reached.

The temperature can be set at between 7°F and -15°F (-14°C and -27°C).

SuperFrost

Fresh food should be frozen completely and as rapidly as possible. This is provided by the SuperFrost feature and ensures that the nutritional value, appearance and flavor of the food remains intact.

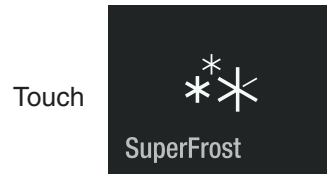

SuperFrost is activated.
Wait 24 hours. Then place the food inside and close the appliance door.

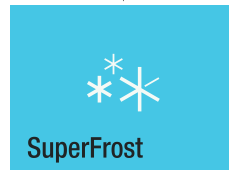

Display when the door is opened again.

The SuperFrost function turns off automatically between 30 and 65 hours depending on the quantity of food placed inside.

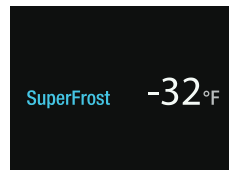

To deactivate SuperFrost earlier, touch the display.

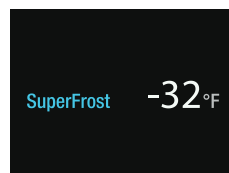

Touch

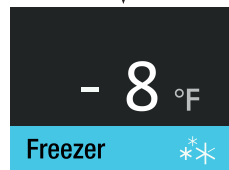

Touch

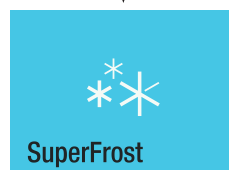

SuperFrost is deactivated.

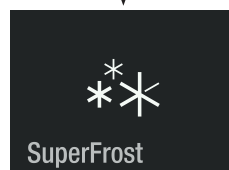

Freezing and Storage

- Pack frozen food in standard freezer bags or reusable plastic, metal or aluminum containers.
- Do not allow fresh food which is to be frozen to come into contact with food already frozen. Always keep packages dry in order to avoid them sticking together.
- Always write the date and contents on the package and do not exceed the stated storage time for the food. This prevents spoiling.
- Pack food which you are freezing yourself in quantities right for your household. To ensure the food freezes right through quickly, the following quantities should not be exceeded per package:
 - fruit, vegetables: up to 2-1/4 lbs (1 kg);
 - meat: up to 5-1/2 lbs (2.5 kg).
- Do not freeze bottles and cans which contain carbonated drinks as they might burst. Drinks can be cooled down quickly, but take the bottles out of the freezer compartment after an hour at the most.
- Only take out as much food as needed for thawing. Cook food which has been thawed as quickly as possible.

Frozen food can be thawed in the following ways:

- in a microwave oven
- in the refrigerator: the safer way to thaw food because there is less chance of bacteria growth. Use this method for high density food such as roasts or poultry.

Safety Instructions and Warnings for the Ice Maker

- The ice maker is designed exclusively to make ice cubes in quantities needed by a household.
- All repairs and work on the ice maker may only be done by customer service personnel or other appropriately trained personnel.
- **Do not consume or use the first three batches of ice. This applies both to using the appliance for the first time and also using it after it has not been used for a long period of time.**
- **The manufacturer cannot accept liability for damage caused by equipment or water lines between the solenoid valve and the water supply.**

Ice Maker Description

The IceMaker is in the top drawer of the appliance.

The ice cubes fall out of the ice maker into the drawer.

When the ice reaches a certain level in the drawer, the appliance stops producing ice automatically.

After you start the ice maker for the first time, it may take up to 24 hours before the first ice cubes are ready.

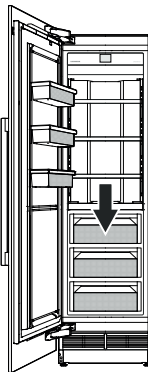

IMPORTANT

The first three batches of ice must not be consumed or used.

Switching the IceMaker on

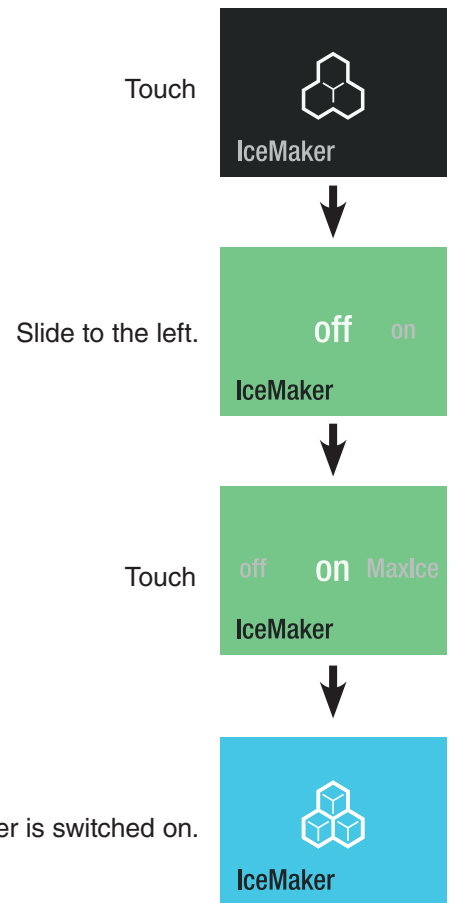

The production capacity is 100 - 120 ice cubes in 24 hours at a temperature of 0°F (-18°C) inside the freezer compartment.

Switching the IceMaker to Maximum Ice Production

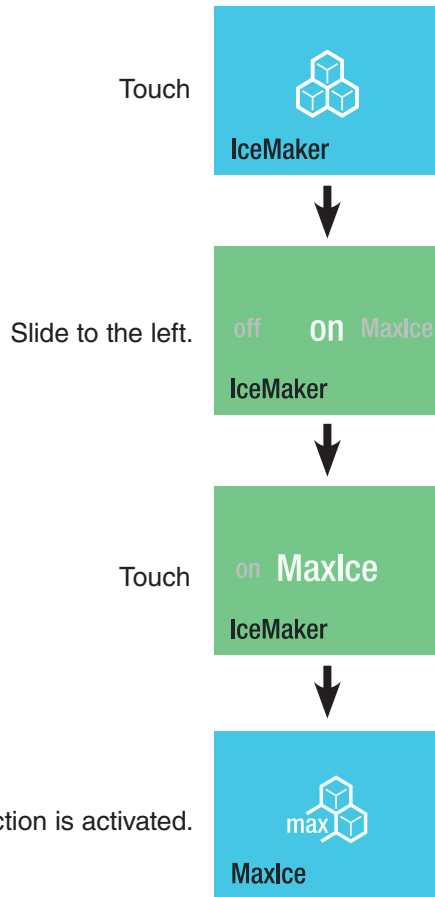

The MaxIce function is activated.

The production capacity is approx. 150 ice cubes in 24 hours.

Be aware that this increases the energy consumption slightly.

PartyMode

When a large quantity of ice cubes is needed or the spontaneous chilling of beverages is planned: Activate PartyMode one day before. Beverages should not be stored in the freezer for more than one hour.

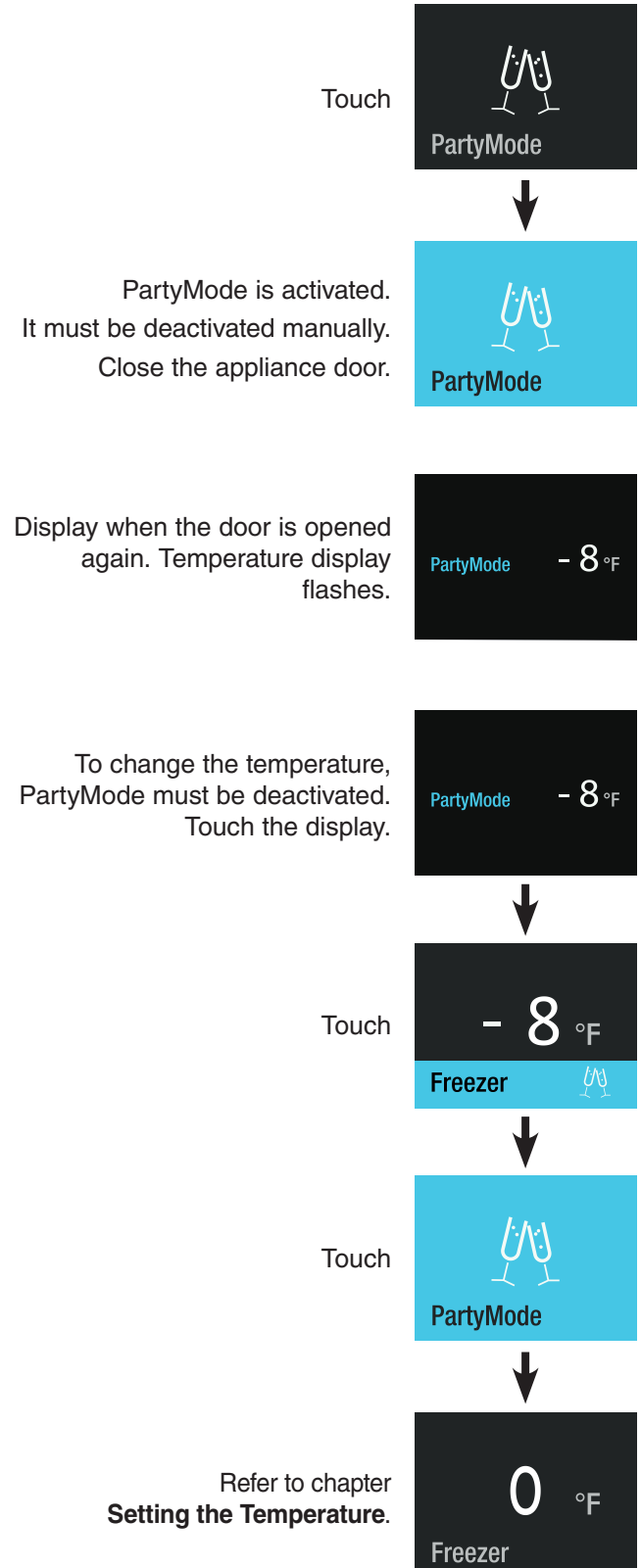

SabbathMode

When SabbathMode is active, some functions of the electronic features are switched off to comply with STAR-K Kosher Certification.

- The lighting remains off.
- There is no door alarm.
- There is no temperature alarm.
- Defrost cycles are independent of the number of times and length of door openings.
- The unit will return to SabbathMode after a power failure.

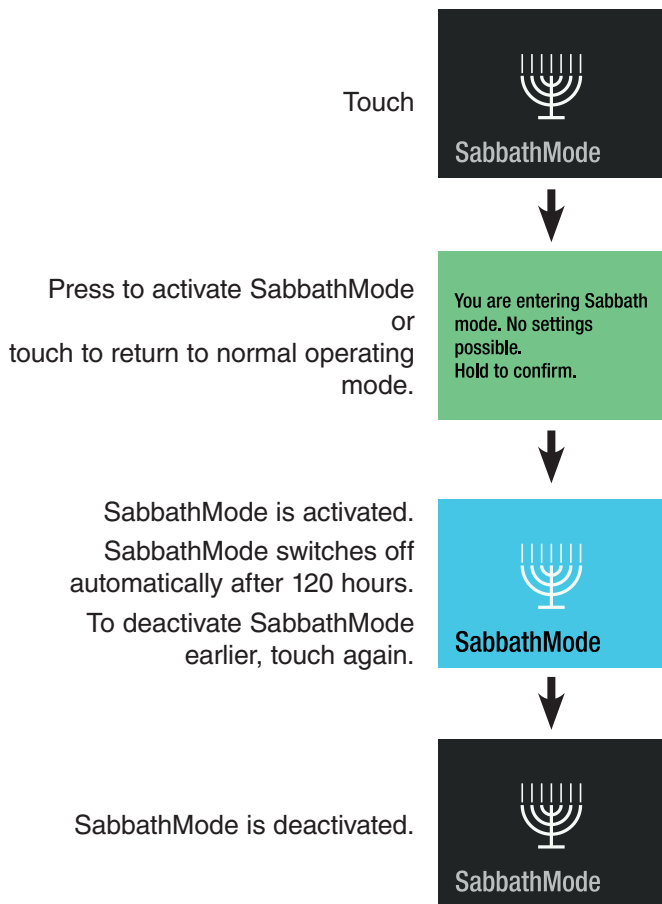

Switching the Appliance Off

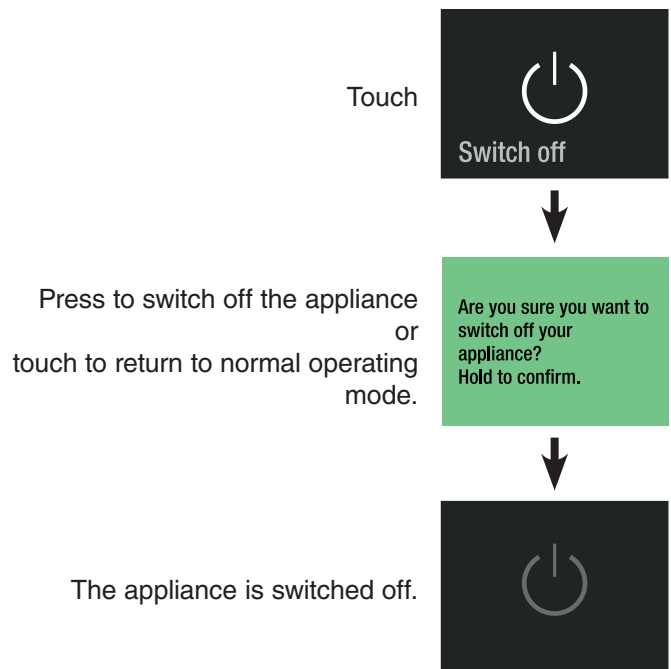

Maintenance Message

In regular intervals of operation of the appliance, the maintenance message comes on. The water filter needs to be changed. The dust filter needs to be cleaned.

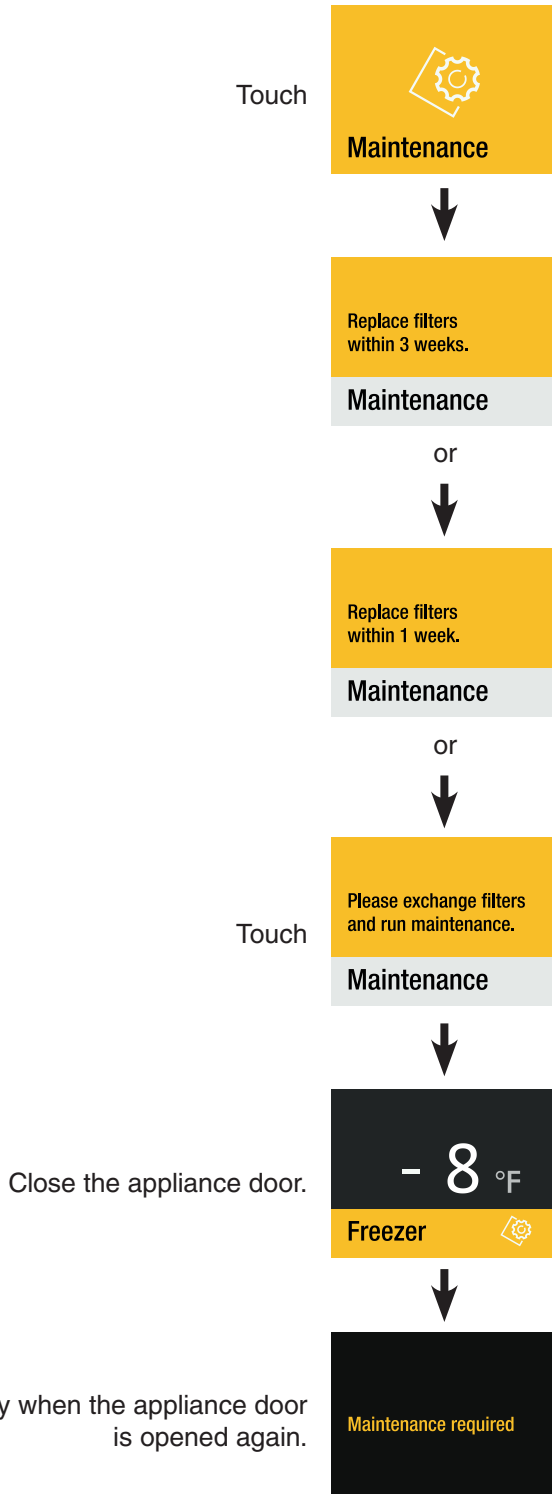

Maintenance Confirmation

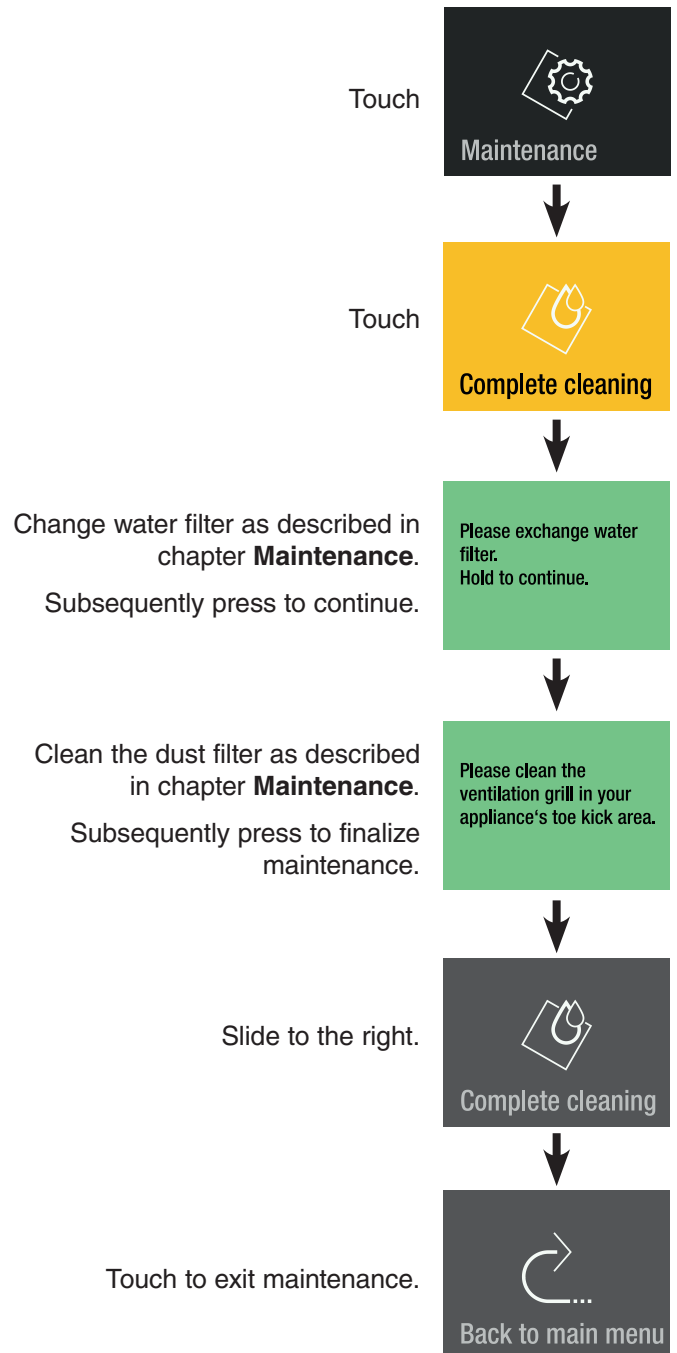

Obtain the water filter from your dealer and complete the maintenance procedure.

Setup Menu

Includes the adjustment for display brightness, activation of the SmartDeviceBox and the device information.

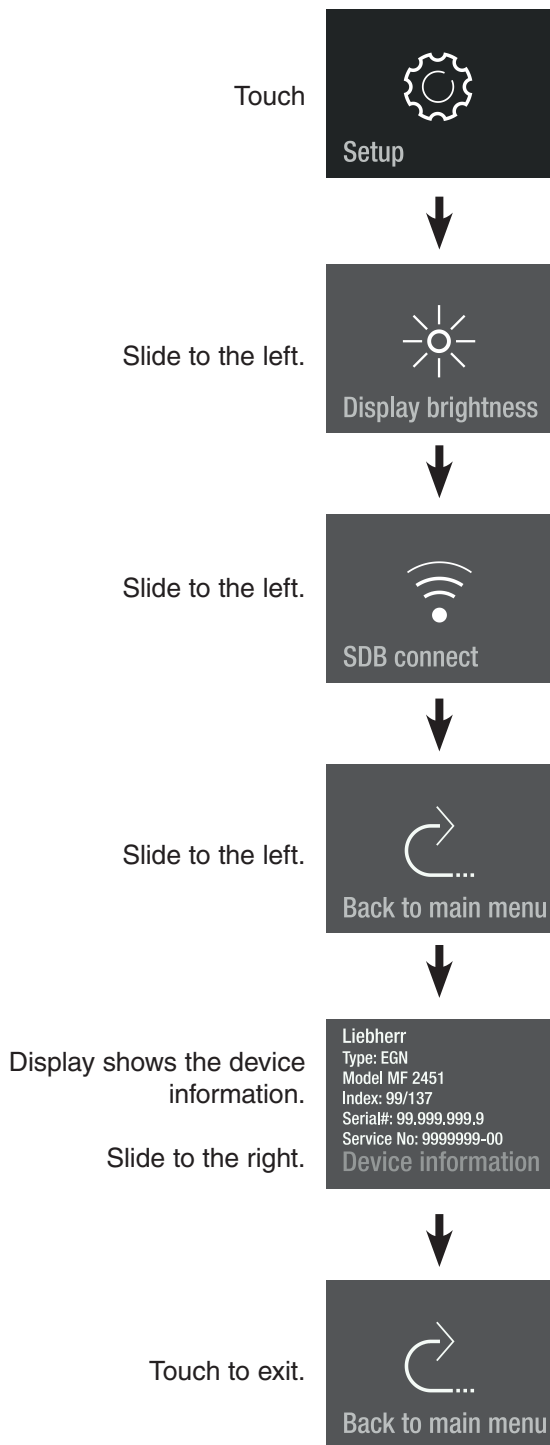

Display Brightness

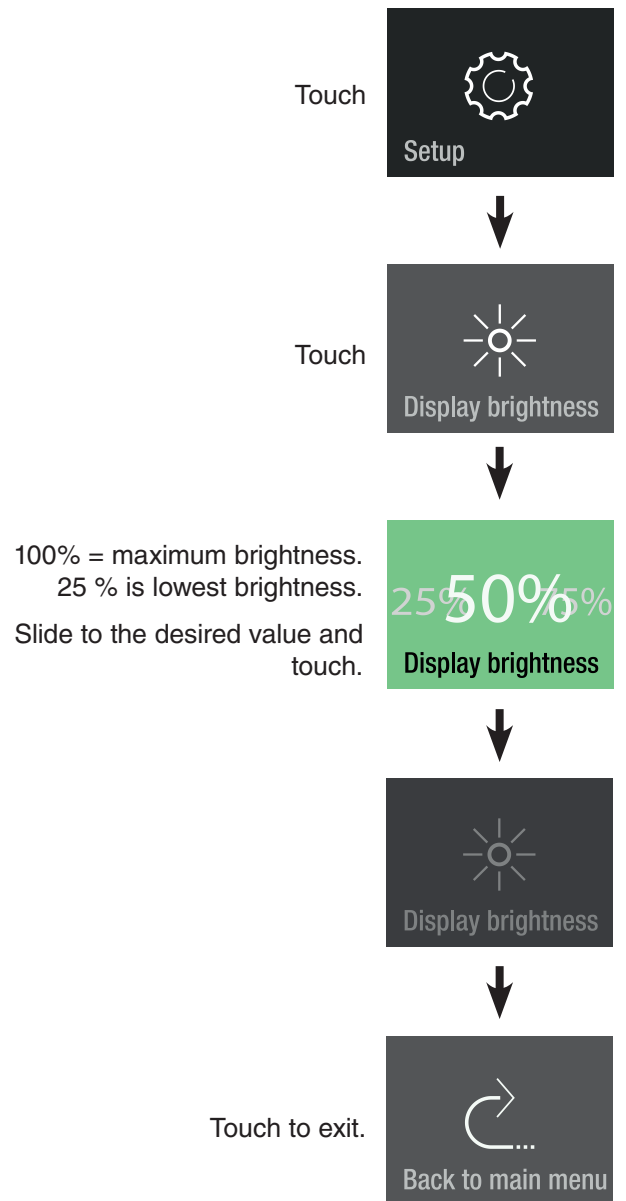

SmartDeviceBox

The appliance is ready for integration into a smart home and for extended services.

Other options can be selected with a SmartDeviceBox.

This is activated via the MyLiebherr customer portal.

You will find more information about availability and prerequisites and the individual options on the website www.smartdevice.liebherr.com/info.

Download the “SmartDevice App” to your smartphone.

Start the app on your smartphone and follow the instructions.

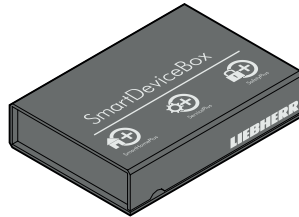

Description of the SmartDevice Displays

SmartDeviceBox is inserted.

Hold to configure now.

SDB inserted

Display to start the WLAN connection.



SDB connect

The symbol flashes.

Connection to WLAN is in progress.



SDB connecting

The router credentials are displayed.

Router_0123456789
01234567890123456

Connecting to:

Appliance is connected to WLAN.



SDB Connected

Connection reset

Reset SDB connection?

This message informs you of any router or Internet problems.



No connection

Alarm Messages

Door Open Alarm

Door has been left open for longer than about 180 seconds.

Action

Close the appliance door.

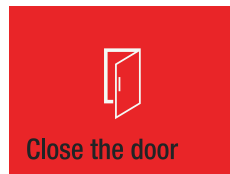

Temperature Alarm

Touch

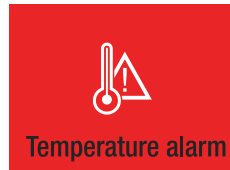

The inside temperature was too high.

Touch



Touch



Action

Check the quality of the stored food.

The alarm display disappears as soon as the set temperature is reached.

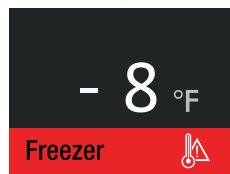

Water alarm

Touch



No water in the system.

Touch

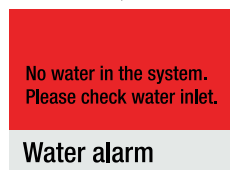

No water in the system.

Action

Open the water supply shut-off valve.

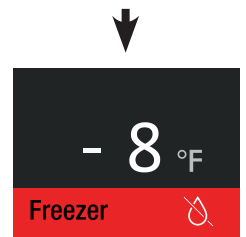

Power Alarm

Touch



Power supply was interrupted.

Touch

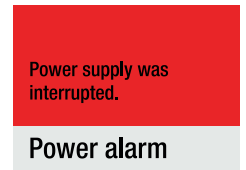

If the temperature inside was too high

Touch



Touch



Action

Check the quality of the stored food.

The alarm display disappears as soon as the set temperature is reached.



Electronic Fault Alarm

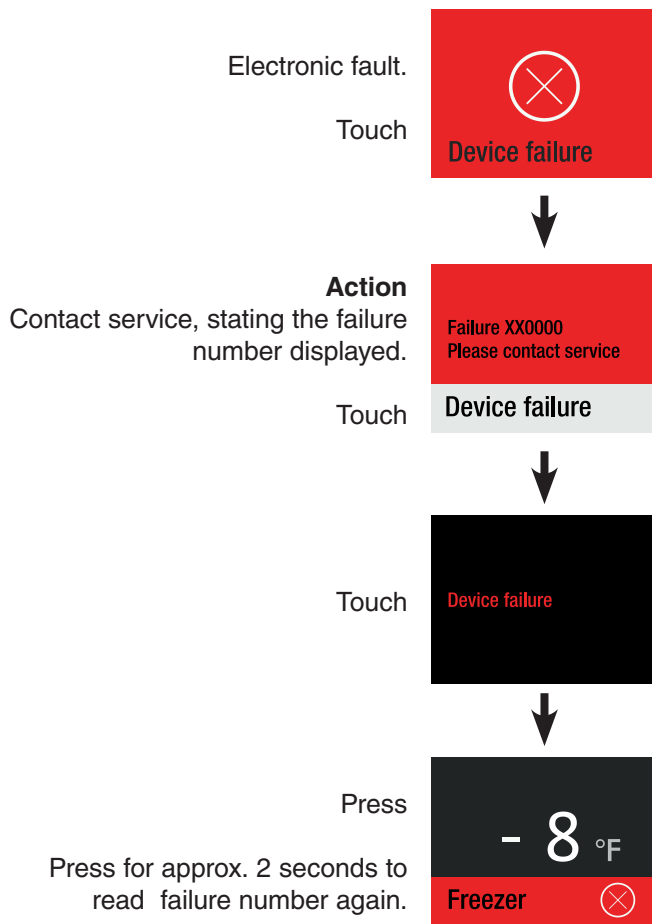

Installing

Insert the hooks of the shelf into the openings of the clip-in strip at the desired height and push down.

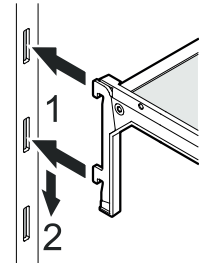

Repositioning the door racks

Removing

Lift the rack up and move out toward you.

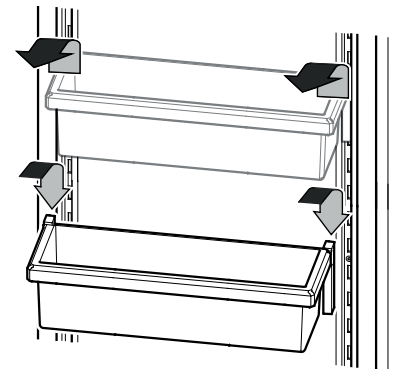

Installing

Insert the hooks of the rack into the openings of the clip-in strip at the desired height and push down.

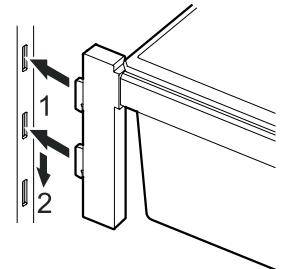

Equipment

You can rearrange the height of the shelves and door racks as required.



Risk of injury and damage.

Do not attempt to adjust a shelf or door rack with food on it.

Only adjust an empty shelf or door rack.

Repositioning the shelves

Removing

Lift the shelf up and move out toward you.

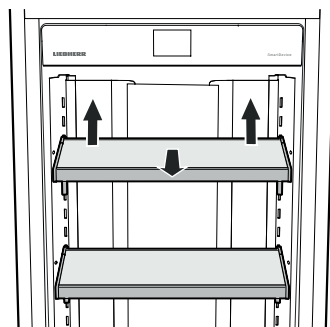

Interior Light

The interior light is located on the left and right in the freezer compartment. It turns on when the appliance door is opened.

The light intensity of the LED light corresponds to laser class 1/1M.

IMPORTANT

The light cover may only be removed by customer service staff.



Risk of eye damage.

If the cover is removed, do not look directly at the light through optical lenses from a close distance.

Cleaning

WARNING!

- To prevent possible injury due to an electric shock, be sure to disconnect the power cord or turn off the circuit breaker before cleaning the appliance.
- To avoid injury or damage, do not use steam cleaning equipment to clean the appliance.
- To avoid short-circuits, ensure no cleaning water penetrates into the electrical components when cleaning the appliance. Do not use a sponge or cloth that is overly wet.
- Remove all food from the freezer compartment and store in a cool place temporarily.
- Remove the glass shelves and door racks. Refer to chapter **Equipment**.

- Remove the drawers. Pull the drawer straight out, grip at the back and lift out.

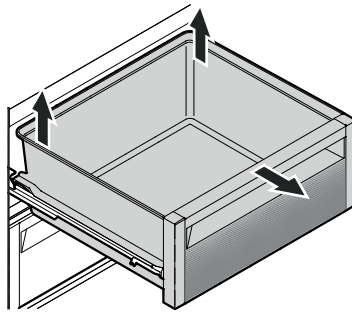

- Clean the inside of the appliance and equipment parts with lukewarm water and a little detergent.

IMPORTANT

Do not use abrasive or scouring pads or sponges. Do not use concentrated cleaning agents. Never use abrasive or acid-based cleaners or chemical solvents.

- Clean the pull-out rails with a slightly dampened cloth only.

IMPORTANT

No cleaning water must be allowed to get into the pull-out rail guides.

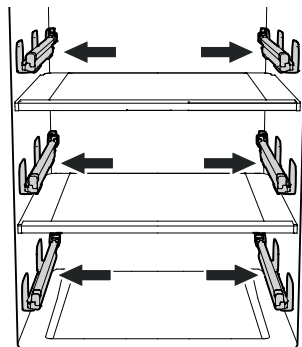

- Dry all parts well with a cloth.
- Do not damage or remove the model plate on the inside of the appliance. It is very important for servicing your appliance.

- Install the drawers. Place the drawer on the rails. The rails must be fully extended and aligned with the front of the drawer. Slide the drawer in.

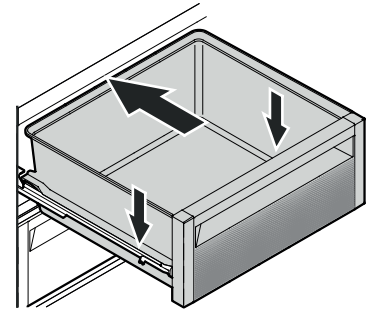

- Install all equipment parts and replace the food in the appliance. Refer to chapter **Equipment**.
- Turn the appliance on.

Maintenance Menu

Maintenance can be carried out independently of the specified regular intervals. The maintenance menu includes the following steps.

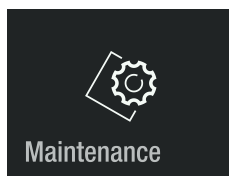

Complete cleaning
For complete maintenance of the appliance.

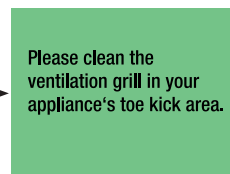
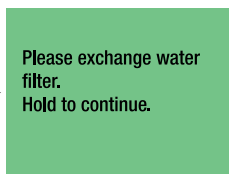
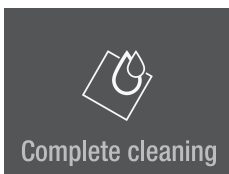

New air filter
To reset maintenance timer.

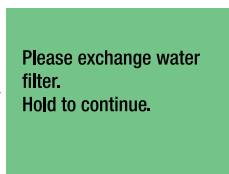
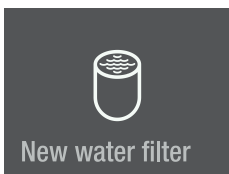

To return to the main menu.

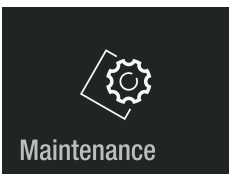
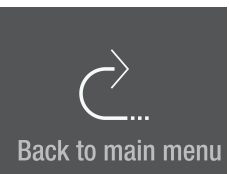

Maintenance

New water filter

The inserted water filter absorbs deposits in the water and reduces the taste of chlorine.

Note

It is not required to turn off the water supply when removing or inserting the filter.

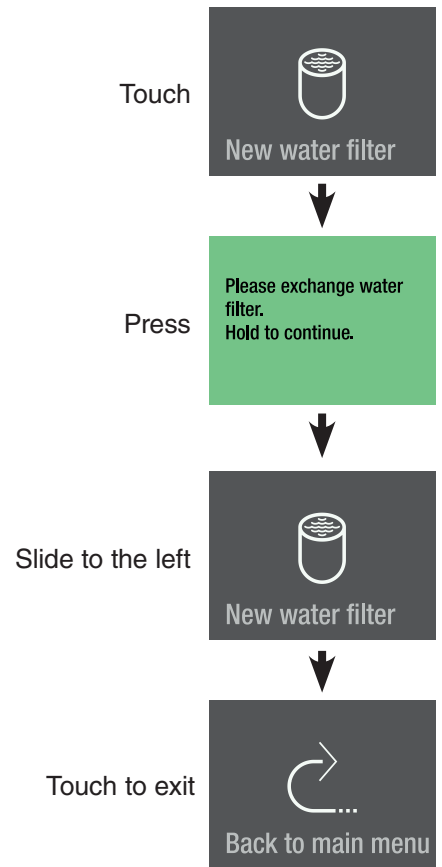
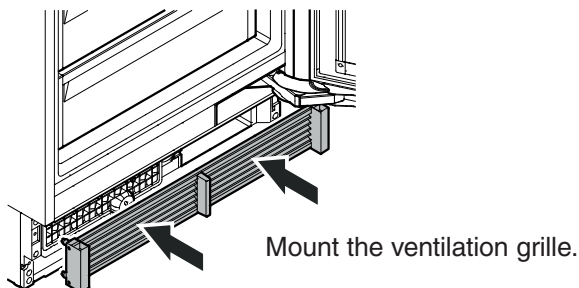
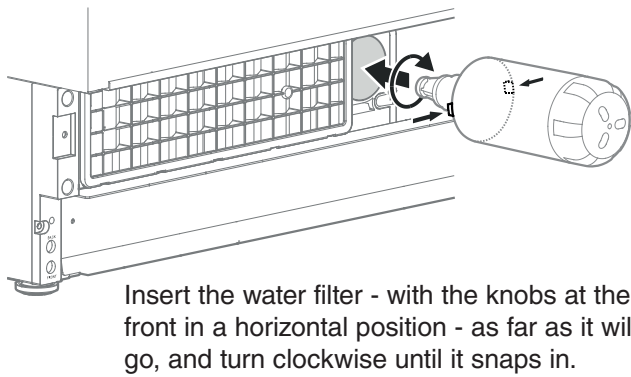
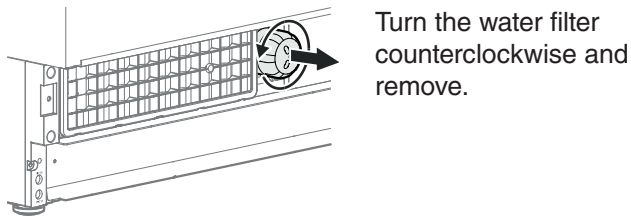
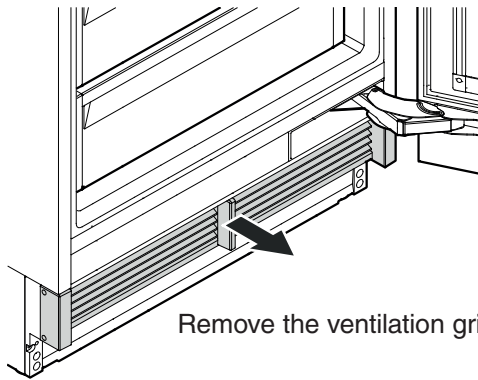

Cleaning the dust filter

Clean the dust filter in the toe kick area at least at the indicated maintenance intervals.

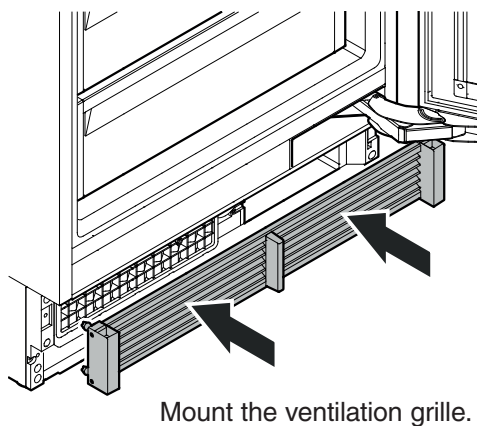
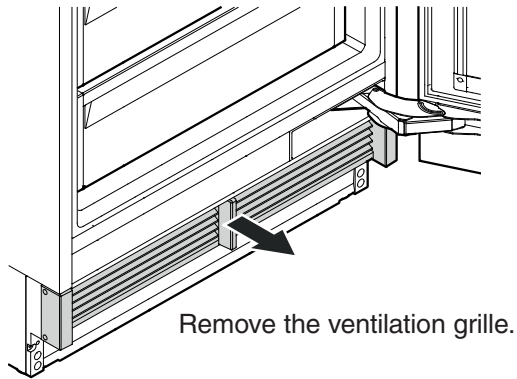

Additional Functions

Water pressure adjustment
 Activating the defrost function manually
 Reset to factory setting
 Demo mode

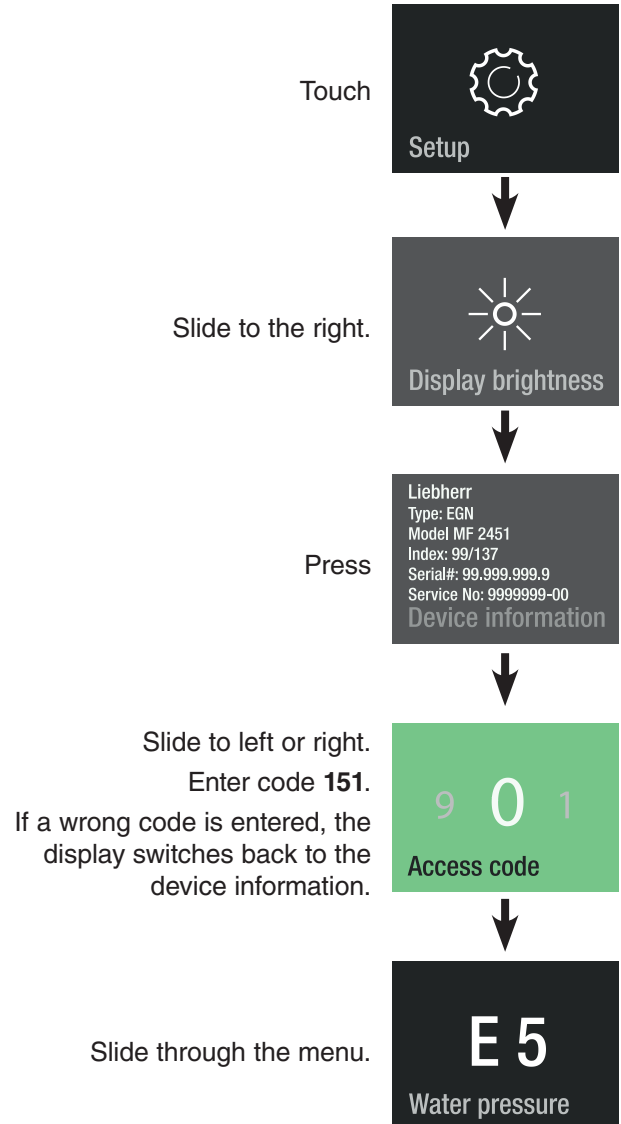

Water pressure

If the ice cubes produced by the ice maker are too small (the first few batches are always smaller), the inflowing water quantity can be adjusted.

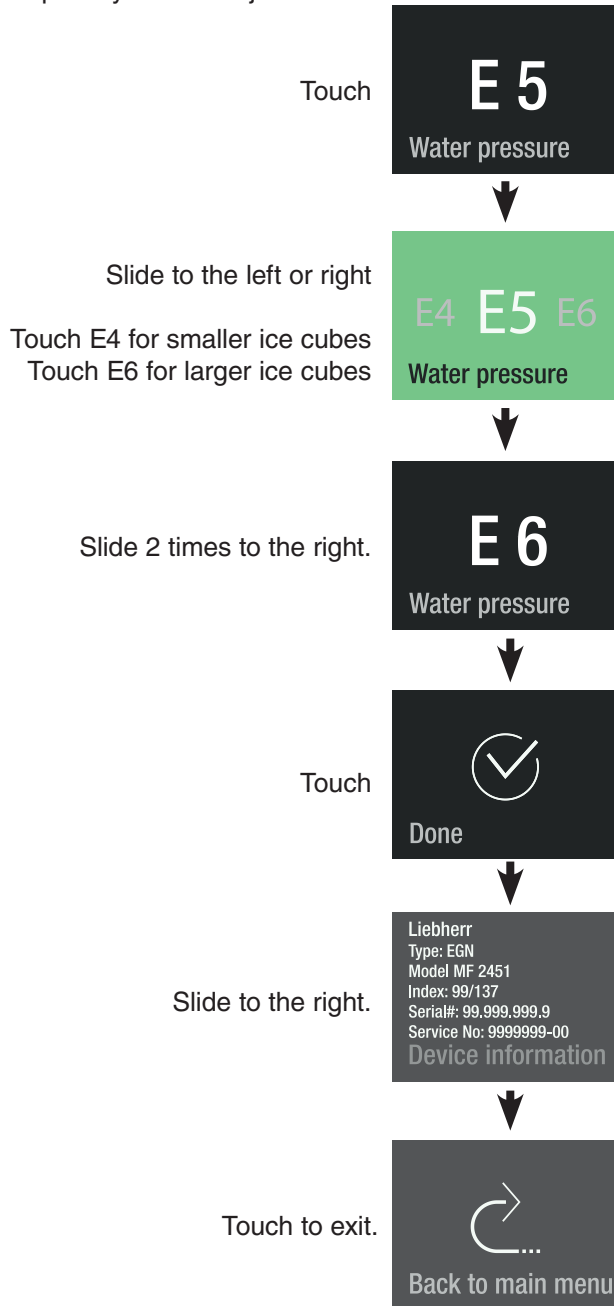

IMPORTANT

Do not increase for more than one step. If the adjusted value is too high, the ice cube tray of the ice maker could overflow.

Check the ice cube size within the next days. If the ice cubes are still smaller than desired, increase the value for one step again.

Manual defrost

The appliance defrosts automatically. The defrost function can be activated manually for service applications.

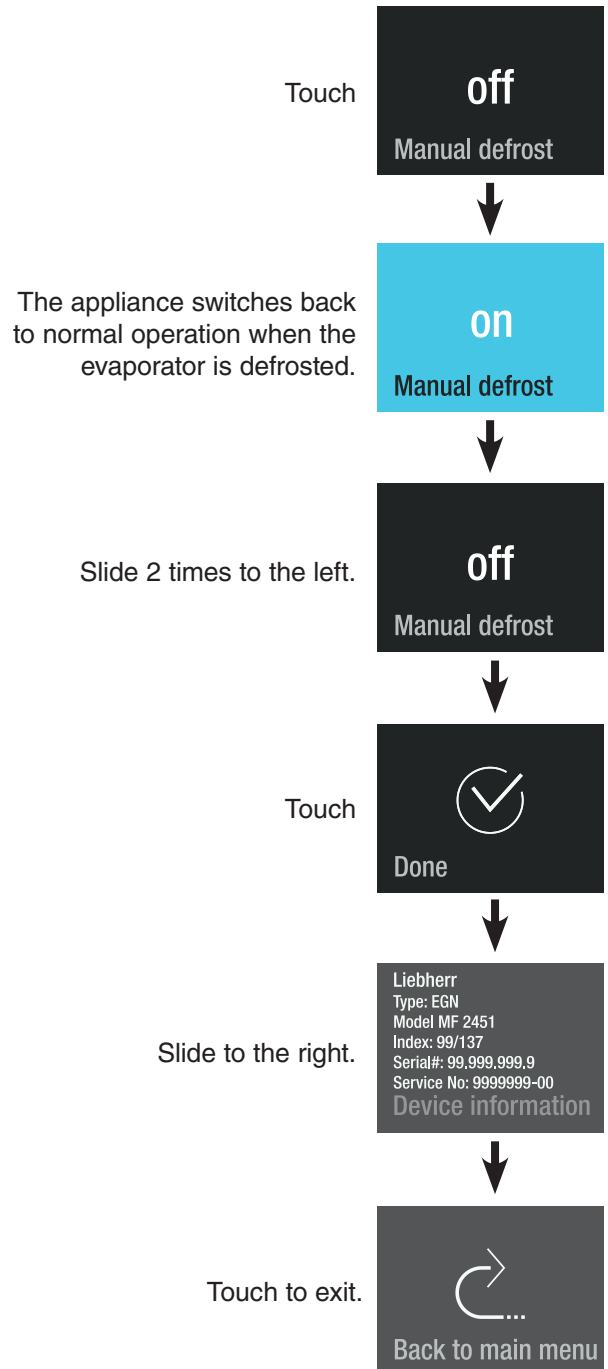

Reset

The electronic control can be reset to factory settings using this function.

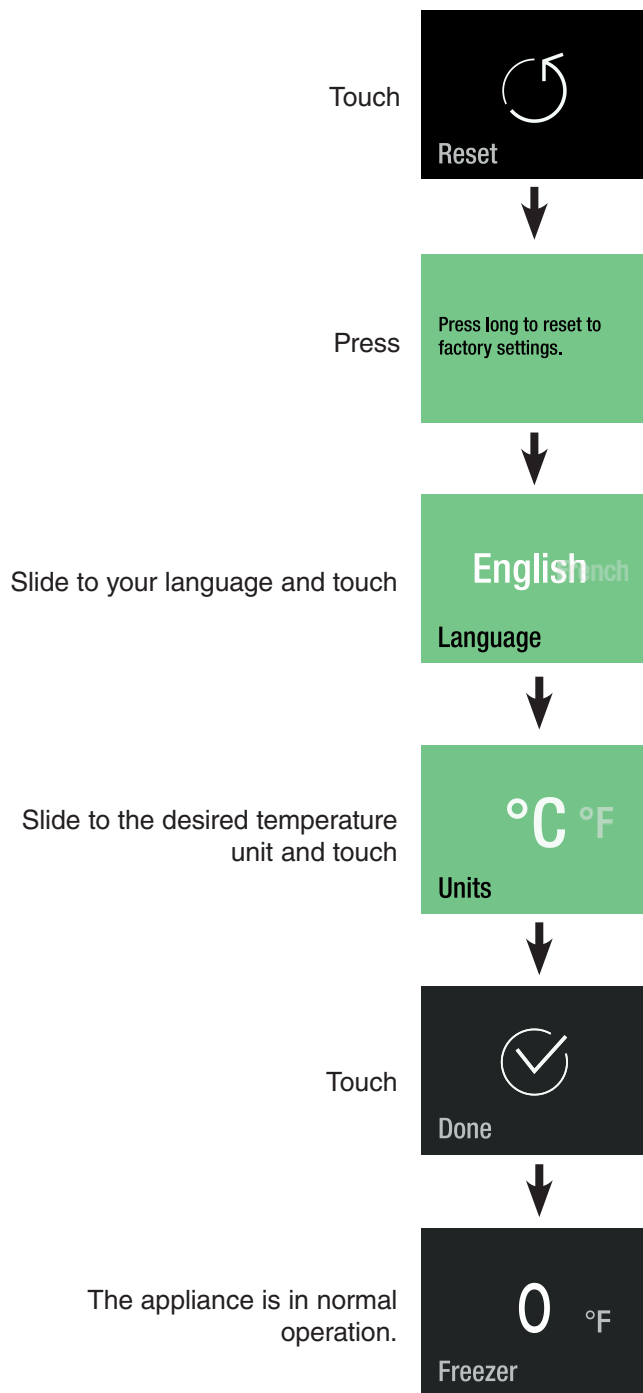

DemoMode

DemoMode can be activated for presenting the appliance at exhibitions or in salesrooms as if it were in normal operating mode.

Activating the DemoMode

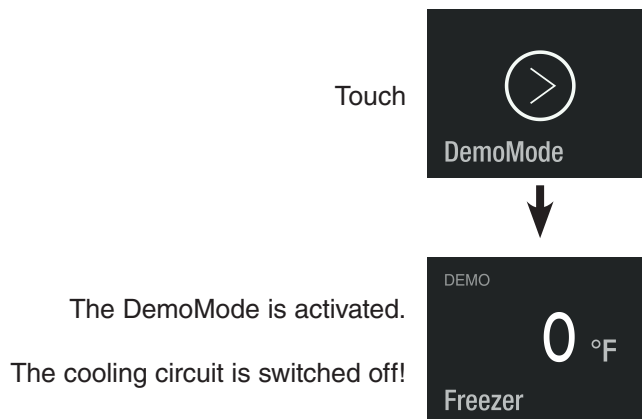

ADDITIONAL FUNCTIONS

Deactivating DemoMode

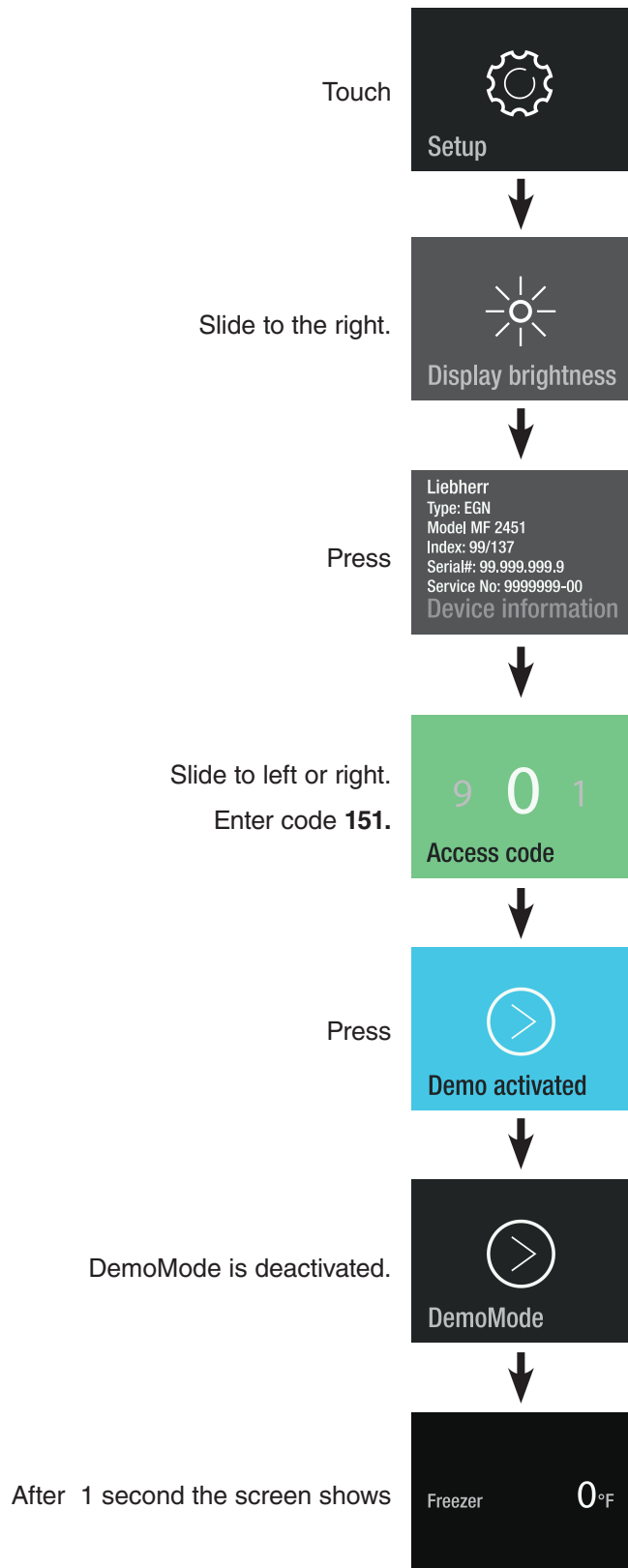

Troubleshooting

If a problem occurs during operation, check whether it is due to an operating error. Please note that even during the warranty period, some repair costs may be your responsibility.

You may be able to correct the following faults by checking the possible causes yourself:

Problem	Possible Cause and Remedy
Appliance does not work, display is off	<ul style="list-style-type: none"> - Is the appliance turned on properly? - Is the power cord properly inserted in the outlet? - Is the circuit breaker or fuse in operating condition?
The interior light does not come on	<ul style="list-style-type: none"> - Is the appliance turned on?
Motor seems to run too long	<ul style="list-style-type: none"> - Is the ambient temperature too warm? See Safety Regulations. - Has the appliance been opened too often or left open too long? - A large amount of food has been added. - Unit is in PartyMode. Verify unit is in normal operation mode.
The temperature is not cold enough	<ul style="list-style-type: none"> - Is the temperature setting correct? See Setting the Temperature. - Has an excessive amount of fresh food been placed in the appliance? - Does a separately installed thermometer show the correct reading? - Is the ventilation system working properly? - Is the appliance set up too close to a heat source?

Customer Service

If none of the above possible causes apply, and you can not rectify the fault yourself, contact your nearest customer service representative.

Indicate the type **(1)** of appliance, service number **(2)** and the appliance / serial number **(3)** as indicated on the model plate or in the device information in the setup menu of the electronic control.

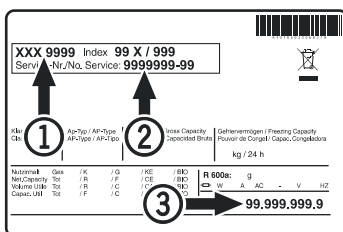

Appliance Information

Record this information when the appliance is installed.

Type Designation: _____

Service Number: _____

Appliance / Serial Number: _____

Date of Purchase: _____

Where Purchased: _____

The position of the model plate is shown in the section entitled **Description of the Appliance**.

LIEBHERR WARRANTY PLAN

FULL TWO YEAR WARRANTY

For two years from the date of original purchase, your Liebherr warranty covers all parts and labor to repair or replace any part of the product which proves to be defective in materials or workmanship.

FULL FIVE YEAR WARRANTY

For five years from the date of original purchase, your Liebherr warranty covers all parts and labor to repair or replace any components that prove to be defective in materials or workmanship in the sealed system. The “Sealed System” means only the compressor, condenser, evaporator, drier and all connecting tubing.

LIMITED 6TH THROUGH 12TH YEAR WARRANTY

From the 6th through 12th year from the date of original purchase, your Liebherr warranty covers all parts that prove to be defective in materials or workmanship in the Sealed System (parts only).

TERMS APPLICABLE TO EACH WARRANTY

All service provided by Liebherr under the warranty must be performed by authorized Liebherr service representatives, unless otherwise specified by Liebherr. Service will be provided in the home during normal business hours. This warranty applies only to products installed for normal residential use. Details regarding a non-residential warranty are available on request.

The warranty applies only to products installed in Canada and any one of the fifty states of the United States or the District of Columbia. This warranty does not cover any parts or labor to correct any defect caused by negligence, accident or improper use, maintenance, installation, service or repair, including but not limited to improper removal and reinstallation of the condensing unit.

THE WARRANTIES DESCRIBED ABOVE ARE MADE EXPRESSLY IN LIEU OF ANY OTHER WARRANTIES, EXPRESSED OR IMPLIED, INCLUDING ANY IMPLIED WARRANTY OF MERCHANTABILITY OR FITNESS FOR A PARTICULAR PURPOSE, AND OF ANY OTHER OBLIGATION OR LIABILITY ON THE PART OF LIEBHERR. IN NO EVENT SHALL LIEBHERR BE LIABLE FOR SPECIAL, INCIDENTAL OR CONSEQUENTIAL DAMAGES ARISING FROM THE BREACH OF THESE WARRANTIES OR ANY OTHER WARRANTIES, WHETHER EXPRESS, IMPLIED OR STATUTORY.

Some States do not allow the exclusion or limitation of incidental or consequential damages so the above limitation or exclusion may not apply to you. This warranty gives you specific legal rights and you may also have other rights which vary from State to State.

To receive parts and/or service and the name of the Liebherr authorized service representative nearest you, contact your Liebherr dealer or distributor or contact the Liebherr designated national service provider:

in the US: Service-appliances.us@liebherr.com, or call 1-866-LIEBHER or 1-866-543-2437

in Canada: www.euro-parts.ca, or call 1-888-LIEBHER, 1-888-543-2437.

For Service in the U.S.

Liebherr Service Center

Toll Free: **1-866-LIEBHER** or **1-866-543-2437**

Email: Service-appliances.us@liebherr.com

PlusOne Solutions, Inc.

3501 Quadrangle Blvd, Suite 120

Orlando, FL 32817

For Service in Canada

Liebherr Service Center

Toll Free: **1-888-LIEBHER** or **1-888-543-2437**

www.euro-parts.ca

EURO-PARTS CANADA

39822 Belgrave Road

Belgrave, Ontario, N0G 1E0

Phone: (519) 357-3320

Fax: (519) 357-1326



www.liebherr-appliances.com